

# EX120

- Rated engine HP ..... 63 kW (85 PS)
- Operating weight..... EX120-2: 11 800 kg (26 000 lb)
- Backhoe bucket..... PCSA heaped: 0.19 — 0.66 m<sup>3</sup>  
(0.25 — 0.86 cu yd)  
CECE heaped: 0.17 — 0.55 m<sup>3</sup>

## Specifications

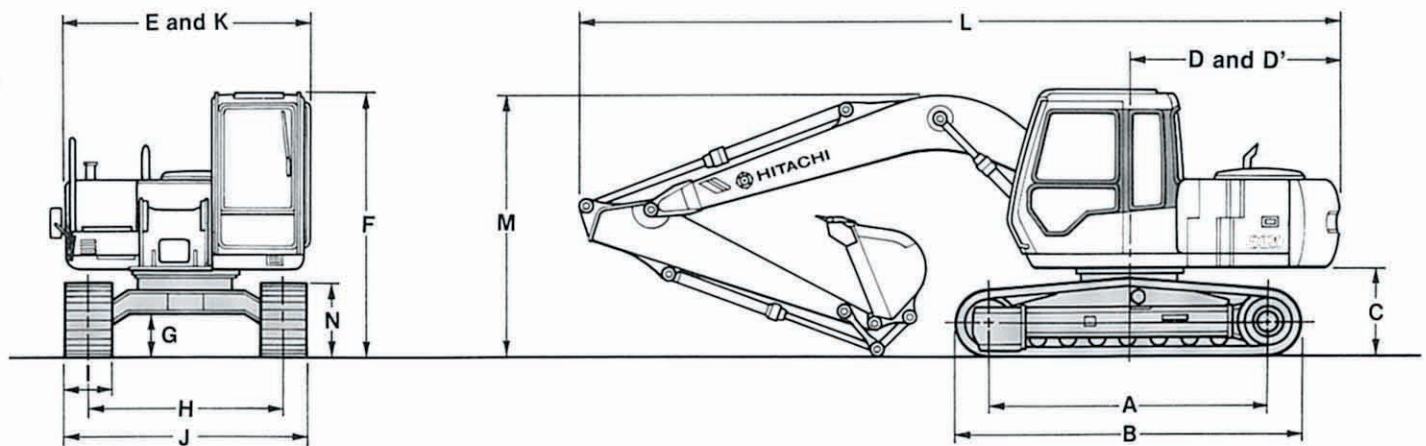

A	Distance between tumblers	2 880 mm (9'5")			
B	Undercarriage length	3 580 mm (11'9")			
*C	Counterweight clearance	890 mm (2'11")			
D	Rear-end swing radius	2 130 mm (7'0")			
D'	Rear-end distance	2 100 mm (6'11")			
E	Overall width of superstructure	2 460 mm (8'1")			
F	Overall height of cab	2 700 mm (8'10")			
*G	Min. ground clearance	440 mm (1'5")			
H	Track gauge	1 990 mm (6'6")			
I	Track shoe width	G 500 mm (20")	G 600 mm (24")	G 700 mm (28")	T 700 mm (28")
J	Undercarriage width	2 490 mm (8'2")	2 590 mm (8'6")	2 690 mm (8'10")	2 690 mm (8'10")
K	Overall width	2 500 mm (8'2")	2 590 mm (8'6")	2 690 mm (8'10")	2 690 mm (8'10")
L	Overall length	7 560 mm (24'10") with 2.10 m (6'11") arm 7 580 mm (24'10") with 2.52 m (8'3") arm 7 580 mm (24'10") with 3.01 m (9'11") arm			
M	Overall height of boom	2 580 mm (8'6") with 2.10 m (6'11") arm 2 690 mm (8'10") with 2.52 m (8'3") arm **2 660 mm (8'9") with 3.01 m (9'11") arm			
N	Track height	790 mm (2'7") with triple grouser shoe 880 mm (2'11") with triangular shoe			

\*Excluding track shoe lug.

\*\*This dimension is shown in the transportation hole position of the arm

G: Triple grouser shoe

T: Triangular shoe

# TECHNICAL DATA

## ENGINE

Model.....	Isuzu 4BD1T
Type .....	Water-cooled, 4-cycle, 4-cylinders in line, direct injection chamber type turbocharged diesel engine
Rated flywheel.....	63 kW (85 PS)
horsepower	at 2 200 rpm
(DIN 6271, net)	
Rated flywheel.....	60 kW (81 HP)
horsepower	at 2 200 rpm
(SAE J1349, net)	
Maximum torque .....	299 N.m (30.5 kgf.m, 221 lbf.ft)
	at 1 600 rpm
Piston displacement .....	3.856 l (235 cu in)
Bore and stroke.....	102 mm × 118 mm (4.02" × 4.65")
Batteries .....	2 × 12 V, 65 AH
Governor .....	Mechanical, all-speed control with stepping motor

## HYDRAULIC SYSTEM

ELLE (Electronic Load-sensing Excavation) system designed for maximum job efficiency and precise, smooth control.

- Load-sensing system
- Flow dividing control system
- Work mode selector
  - General-purpose mode / Trenching mode
  - Grading mode / Precision mode

Power selector designed for maximum productivity and fuel savings.

- Engine speed sensing system
  - P (Power) mode / E (Economy) mode
  - L (Low speed) mode / I (Low idle) mode

Main pumps.....	1 variable displacement axial piston pump
Maximum oil flow.....	1 × 198 l/min
	(52.3 US gpm, 43.6 Imp gpm)
Pilot pump.....	Gear pump
Maximum oil flow.....	37.0 l/min
	(9.8 US gpm, 8.1 Imp gpm)

### Relief Valve Settings

Implement circuit.....	34.3 MPa (350 kgf/cm <sup>2</sup> , 4 980 psi)
Swing circuit.....	34.8 MPa (355 kgf/cm <sup>2</sup> , 5 050 psi)
Travel circuit.....	34.3 MPa (350 kgf/cm <sup>2</sup> , 4 980 psi)
Pilot circuit.....	4.9 MPa ( 50 kgf/cm <sup>2</sup> , 710 psi)

### Hydraulic Cylinders

High-strength piston rods and tubes. Cylinder cushion mechanisms provided in all cylinders to absorb shocks at stroke ends.

### Dimensions

	Quan.	Bore	Rod diameter
Boom	2	105 mm (4.13")	70 mm (2.76")
Arm	1	110 mm (4.33")	80 mm (3.15")
Bucket	1	95 mm (3.74")	65 mm (2.56")

## Hydraulic Filters

All hydraulic circuits have high-quality hydraulic filters for protection against oil contamination and for longer life of hydraulic equipment. A suction filter is incorporated in suction line, and 10µm full-flow filters in return line and swing/travel motor drain lines.

## CONTROLS

Pilot controls (for all operations), Hitachi's original shockless valve and quick warm-up system are built in the pilot circuit for easy, precise, fatigue-free operation. Hydraulic warm-up control system for engine and hydraulic oil. Multi selection lever with rotary valve is optionally available for simple selection of control lever direction.

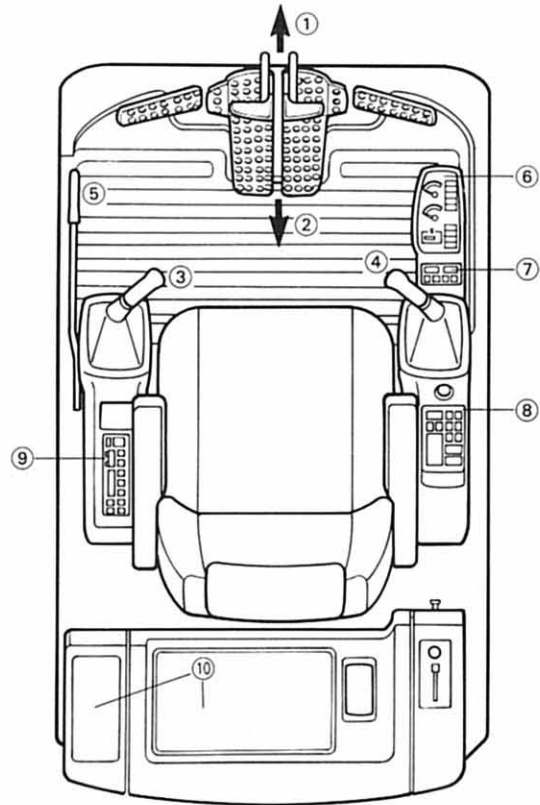

- ① Travel forward ( levers )
- ② Travel reverse ( with pedals )
- ③ Swing / Arm control lever
- ④ Boom / Bucket control lever
- ⑤ Pilot control shut-off lever
- ⑥ Monitor panel
- ⑦ Switch panel I
- ⑧ Switch panel II
- ⑨ Auto turning radio
- ⑩ Rear tray



## SUPERSTRUCTURE

### Revolving Frame

Welded high-strength box construction using heavy-gauge steel plates for high ruggedness. Reinforced D-section frame featuring high resistance to deformation.

### Swing Mechanism

High-torque, axial piston motor with planetary reduction gear is bathed in oil. Swing circle is single-row, shear-type ball bearing with induction-hardened internal gear. Internal gear and pinion gear are immersed in lubricant. Swing parking brake is spring-set/hydraulic-released disc type. Swing dampener valve in the swing circuit prevents coasting when stopping swing. Swing cushion valve built in swing motor absorbs shocks when stopping swing, ensuring smooth stops.

Swing speed..... 11.0 min<sup>-1</sup> (11.0 rpm)

### Operator's Cab

Independent roomy cab, 940 mm (37") wide by 1 620 mm (64") high, conforming to ISO\* Standards. Reinforced glass windows on all 4 sides for all-round visibility. Front windows (upper and lower), fully openable, are spring-assisted for easy storing in the cab and for absorbing shocks during lowering. Fully adjustable, suspension seat with armrests; movable with or without control levers and monitor panel.

International Standard Organization



## UNDERCARRIAGE

### Tracks

Tractor-type undercarriage. Heavy-duty track frame of all welded structure. Top-grade materials employed for heavy-duty operation. Side frames are rigidly welded to the track frame.

Lifetime-lubricated track rollers, idlers, and sprockets with floating seals. Track shoes with triple grousers made of induction-hardened rolled alloy. Flat and triangular shoes also available. Specially heat-treated connecting pins with dirt seals. Hydraulic (grease) track adjusters with shock-absorbing recoil springs.

### Numbers of Rollers and Shoes on Each Side

Upper roller..... 1  
 Lower rollers ..... 7  
 Track shoes ..... 44

### Traction Device

Each track driven by a high-torque, axial piston 2 speed travel motor through planetary reduction gear, allowing counterrotation of the tracks. Sprockets are easily replaceable. Parking brake is spring-set/hydraulic-released disc type. Travel shockless relief valve built in travel motor absorbs shocks when stopping travel, ensuring smooth stops.

Automatic transmission system; High—Medium.

Travel speeds ..... High: 0 to 5.5 km/h (3.4 mph)  
 Medium: 0 to 3.4 km/h (2.1 mph)  
 Low: 0 to 2.5 km/h (1.6 mph)

Maximum traction force ..... 94.1 kN  
 (9 600 kgf, 21 200 lbf)

Gradeability ..... 35° (70%) continuous

## WEIGHTS AND GROUND PRESSURE

Equipped with 4.60 m (15' 1") boom, 2.52 m (8' 3") arm and 0.55 m<sup>3</sup> (PCSA heaped) bucket.

Shoe type	Shoe width	Operating weight	Ground pressure
Triple grouser	500 mm (20")	11 800 kg (26 000 lb)	37.3 KPa (0.38 kgf/cm <sup>2</sup> , 5.40 psi)
	600 mm (24")	12 100 kg (26 700 lb)	31.4 KPa (0.32 kgf/cm <sup>2</sup> , 4.55 psi)
	700 mm (28")	12 300 kg (27 100 lb)	27.5 KPa (0.28 kgf/cm <sup>2</sup> , 3.98 psi)
Flat type	510 mm (20")	12 300 kg (27 100 lb)	38.2 KPa (0.39 kgf/cm <sup>2</sup> , 5.55 psi)
Triangular type	700 mm (28")	12 100 kg (26 700 lb)	27.5 KPa (0.28 kgf/m <sup>2</sup> , 3.98 psi)

Operating weight implies total weight of the basic machine plus 2 350 kg (5 180 lb) counterweight and triple grouser shoes, excluding front-end attachment.

9 630 kg (21 200 lb) with 500 mm (20") shoes.



## SERVICE REFILL CAPACITIES

	liters	US gal	Imp gal
Fuel tank .....	250.0	66.0	55.0
Engine coolant .....	16.4	4.3	3.6
Engine oil .....	16.2	4.3	3.6
Swing mechanism .....	4.0	1.1	0.9
Travel final drive .....	3.5	0.9	0.8
device (each side)			
Hydraulic system .....	134.0	35.4	29.5
Hydraulic tank .....	69.0	18.2	15.2



# TECHNICAL DATA



## BACKHOE ATTACHMENTS

Boom and arms are of all-welded, low-stress, full box-section design. 4.60 m (15'11") boom, and 2.10 m (6'11"), 2.52 m (8'3") and 3.01 m (9'11") arms are available. Bucket is of all-welded, high-strength steel structure. Side clearance adjust mechanism provided on the bucket joint bracket.



## WORKING RANGES

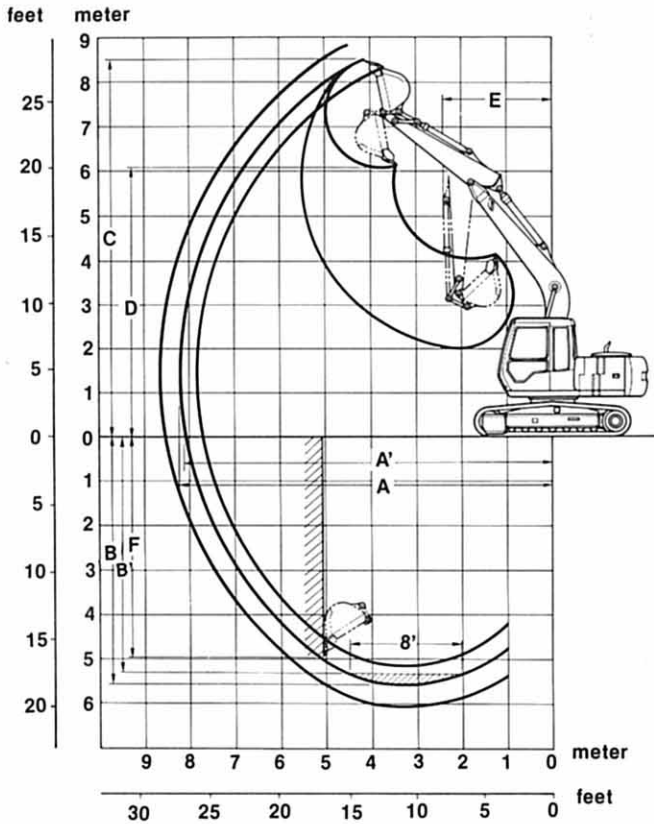

Arm length	2.10 m (6'11")	2.52 m (8'3")	3.01 m (9'11")
A Max. digging reach	7 900 mm (25'11")	8 270 mm (27'2")	8 740 mm (28'8")
A' Max. digging reach (on ground)	7 770 mm (25'6")	8 140 mm (26'8")	8 610 mm (28'3")
B Max. digging depth	5 150 mm (16'11")	5 570 mm (18'3")	6 060 mm (19'11")
B' Max. digging depth (8' level)	4 920 mm (16'2")	5 360 mm (17'7")	5 880 mm (19'3")
C Max. cutting height	8 330 mm (27'4")	8 520 mm (27'11")	8 840 mm (29'0")
D Max. dumping height	5 920 mm (19'5")	6 120 mm (20'1")	6 440 mm (21'2")
E Min. swing radius	2 370 mm (7'9")	2 390 mm (7'10")	2 620 mm (8'7")
F Max. vertical wall	4 640 mm (15'3")	4 980 mm (16'4")	5 450 mm (17'11")
Bucket digging force	78.5 kN (8 000 kgf, 17 600 lbf)	78.5 kN (8 000 kgf, 17 600 lbf)	78.5 kN (8 000 kgf, 17 600 lbf)
Arm crowd force	64.7 kN (6 600 kgf, 14 600 lbf)	57.9 kN (5 900 kgf, 13 000 lbf)	52.0 kN (5 300 kgf, 11 700 lbf)

Excluding track shoe lug

## Buckets

Capacity		Width		No. of teeth	Weight	Recommendation		
PCSA heaped	CECE heaped	Without side cutters	With side cutters			2.10 m (6'11") arm	2.52 m (8'3") arm	3.01 m (9'11") arm
0.19 m <sup>3</sup> (0.25 cu yd)	0.17 m <sup>3</sup>	450 mm (18")	550 mm (22")	3	240 kg ( 530 lb)	⊙	⊙	⊙
0.30 m <sup>3</sup> (0.39 cu yd)	0.25 m <sup>3</sup>	580 mm (23")	700 mm (28")	3	280 kg ( 620 lb)	⊙	⊙	⊙
0.40 m <sup>3</sup> (0.52 cu yd)	0.33 m <sup>3</sup>	680 mm (27")	800 mm (31")	4	320 kg ( 710 lb)	⊙	⊙	⊙
0.46 m <sup>3</sup> (0.60 cu yd)	0.40 m <sup>3</sup>	850 mm (33")	970 mm (38")	5	370 kg ( 820 lb)	⊙	⊙	○
0.55 m <sup>3</sup> (0.72 cu yd)	0.45 m <sup>3</sup>	890 mm (35")	1 010 mm (40")	5	390 kg ( 860 lb)	⊙	⊙	○*
0.59 m <sup>3</sup> (0.77 cu yd)	0.50 m <sup>3</sup>	950 mm (37")	1 070 mm (42")	5	410 kg ( 900 lb)	⊙	○	—
0.66 m <sup>3</sup> (0.86 cu yd)	0.55 m <sup>3</sup>	1 030 mm (41")	—	5	400 kg ( 880 lb)	□	—	—
One-point ripper				1	320 kg ( 710 lb)	●	●	—
Clamshell bucket: 0.30 m <sup>3</sup> (0.39 cu yd): CECE heaped, Width-560 mm (22")				6	690 kg (1 520 lb)	⊙	⊙	—
Slope-finishing blade: Width-1 000 mm (39"), Length-1 600 mm (63")					475 kg (1 050 lb)	◇	◇	◇

\* With 700 mm (28") shoes only

- ⊙ Suitable for materials with density of 2 000 kg/m<sup>3</sup> (3 370 lb/cu yd) or less
- Suitable for materials with density of 1 600 kg/m<sup>3</sup> (2 700 lb/cu yd) or less
- Suitable for materials with density of 1 100 kg/m<sup>3</sup> (1 850 lb/cu yd) or less
- Heavy-duty service
- ◇ Slope finishing service
- Not recommended

## SE STANDARD EQUIPMENT

Standard equipment may vary by country, so please consult your Hitachi dealer for details.

### Cab

All-weather sound-suppressed steel cab equipped with reinforced, tinted (bronze color) glass windows, openable front windows — upper with assist spring, and lower and both side windows with intermittent windshield wipers, front window washer, adjustable suspension seat with armrests, electric double horn, auto-tuning radio with digital clock, auto-idle switch, cigarette lighter, ashtray, parcel pocket, rear tray, floor mat, heater, and Pilot control shut-off lever.

### Monitor system

- Meters  
Hourmeter, engine coolant temperature gauge, and fuel meter
- Warning lamps  
Alternator charge, engine oil pressure, engine overheat, air cleaner clog, minimum fuel lever
- Pilot lamps  
Engine preheat, engine oil level, engine coolant level and hydraulic oil level
- Alarm buzzers  
Engine oil pressure, and engine overheat

### Lights

- 3 working lights, and 1 cab light.

### Superstructure

Full undercover for noise suppression, 2 350 kg (5 180 lb) counterweight, large tool box, utility space, rearview mirror, cartridge-type filters for engine oil and fuel, heavy-duty air cleaner with evacuator valve, radiator and oil cooler with dust-proof net, radiator reserve tank, boom-arm holding valve, hydraulic warm-up control system for engine and hydraulic oil, quick warm-up system for pilot circuit, accumulator for pilot circuit, control valve with main relief valve.

### Undercarriage

Hydraulic brake valves for travel circuit, travel motor covers, tack guards, and hydraulic track adjuster.

### Miscellaneous

Standard tool kit, lockable machine covers, fuel filling cap, non-slip tapes, and handrails.

### Type of Bucket

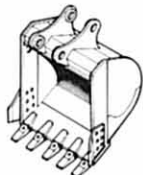

Backhoe bucket

### Type of Shoe



Triple grouser shoe  
500 mm (20")

## SE OPTIONAL EQUIPMENT

Standard equipment may vary by country, so please consult your Hitachi dealer for details.

- Air conditioner
- Multi selection lever with rotary valve
- Hose rupture valves
- Electric fuel refilling pump
- Swing motion alarm device with lamp
- Travel motion alarm device
- Additional pump
- Piping kit for extra port
- PTO valve & Additional valve with piping kit

- One-point ripper for ripping hardpan
- Clamshell bucket for deep, vertical excavations like manholes, pilings, footings, etc.
- Slope-finishing blade for slope finishing jobs . . . scraping up or down, compacting, leveling, grading etc.

### Type of Bucket



One-point ripper

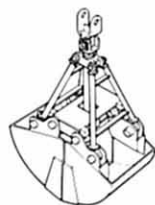

Clamshell bucket



Slope-finishing blade

### Type of Shoe



Triple grouser shoe  
600 mm (24"), 700 mm (28")



Flat shoe  
510 mm (20")

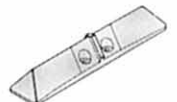

Triangular shoe  
700 mm (28")

# LIFTING CAPACITIES

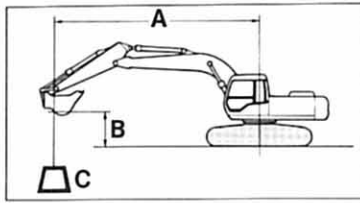

**A:** Load radius  
**B:** Load point height  
**C:** Lifting capacity

Rating over-side or 360 degrees Rating over-front















Unit: 1 000 kg (1 000 lb)

Conditions	Load point height m (ft in)	Load radius												m (ft in)		At max. reach						
		2 (6'7")		3 (9'10")		4 (13'1")		5 (16'5")		6 (19'8")		7 (23'0")		m (ft in)	m (ft in)							
Boom 4.60 m (15'1") Arm 2.10 m (6'11") Bucket PCSA: 0.55 m <sup>3</sup> (0.72 cu yd) CECE: 0.45 m <sup>3</sup> Shoes 500 mm (20")	6 (19'8")											*1.96 (4.32)	*1.96 (4.32)			*1.39 (3.06)	*1.39 (3.06)	6.13 (20'1")				
	5 (16'5")											2.61 (5.76)	*2.95 (6.50)			*1.33 (2.93)	*1.33 (2.93)	6.81 (22'4")				
	4 (13'1")											*3.27 (7.21)	*3.27 (7.21)	2.56 (5.64)	*3.15 (6.95)	1.84 (4.06)	2.73 (6.02)			1.30 (2.87)	*1.30 (2.87)	7.25 (23'9")
	3 (9'10")			*5.37 (11.8)	*5.37 (11.8)	3.57 (7.87)	*4.13 (9.11)	2.47 (5.45)	*3.55 (7.83)	1.80 (3.97)	2.69 (5.93)			1.19 (2.62)	*1.32 (2.91)	7.51 (24'8")						
	2 (6'7")					3.34 (7.36)	*5.10 (11.2)	2.35 (5.18)	3.54 (7.81)	1.74 (3.84)	2.62 (5.78)	1.31 (2.89)	*1.94 (4.28)	1.13 (2.49)	*1.36 (3.00)	7.60 (24'11")						
	1 (3'3")					3.14 (6.92)	4.92 (10.8)	2.24 (4.94)	3.43 (7.56)	1.68 (3.70)	2.55 (5.62)	1.29 (2.84)	1.98 (4.37)	1.13 (2.49)	*1.44 (3.18)	7.55 (24'9")						
	0 (Ground)					3.04 (6.70)	4.79 (10.6)	2.17 (4.78)	3.34 (7.36)	1.63 (3.59)	2.50 (5.51)	1.26 (2.78)	1.96 (4.32)	1.17 (2.58)	*1.56 (3.44)	7.33 (24'1")						
	-1 (-3'3")			4.81 (10.6)	*5.20 (11.5)	3.00 (6.62)	4.75 (10.5)	2.12 (4.67)	3.29 (7.25)	1.60 (3.53)	2.47 (5.45)			1.29 (2.84)	*1.75 (3.86)	6.94 (22'9")						
	-2 (-6'7")	*5.33 (11.8)	*5.33 (11.8)	4.85 (10.7)	*7.45 (16.4)	3.00 (6.62)	4.75 (10.5)	2.12 (4.67)	3.29 (7.25)	1.60 (3.53)	2.48 (5.49)			1.51 (3.33)	*2.06 (4.54)	6.34 (20'10")						
	-3 (-9'10")	*6.19 (13.6)	*6.19 (13.6)	4.93 (10.9)	*6.60 (14.6)	3.05 (6.73)	4.81 (10.6)	2.15 (4.74)	3.33 (7.34)					1.98 (4.37)	*2.62 (5.78)	5.43 (17'10")						
	-4 (-13'1")			*5.02 (11.1)	*5.02 (11.1)	3.15 (6.95)	*3.98 (8.78)															

Boom 4.60 m (15'1") Arm 2.52 m (8'3") Bucket PCSA: 0.55 m <sup>3</sup> (0.72 cu yd) CECE: 0.45 m <sup>3</sup> Shoes 500 mm (20")	6 (19'8")											*2.22 (4.90)	*2.22 (4.90)			*1.18 (2.60)	*1.18 (2.60)	6.59 (21'7")		
	5 (16'5")											2.56 (5.64)	*2.56 (5.64)	1.89 (4.17)	*1.99 (4.39)			*1.13 (2.49)	*1.13 (2.49)	7.22 (23'8")
	4 (13'1")											2.61 (5.76)	*2.78 (6.13)	1.88 (4.15)	*2.55 (5.62)			*1.12 (2.47)	*1.12 (2.47)	7.63 (25'0")
	3 (9'10")			*3.60 (7.94)	*3.60 (7.94)	*3.45 (7.61)	*3.45 (7.61)	2.51 (5.53)	*3.25 (7.17)	1.83 (4.04)	2.72 (6.00)	1.36 (3.00)	*1.96 (4.32)	1.09 (2.40)	*1.13 (2.49)	7.87 (25'10")				
	2 (6'7")			5.21 (11.5)	*6.48 (14.3)	3.41 (7.52)	*4.66 (10.3)	2.39 (5.27)	3.59 (7.92)	1.76 (3.88)	2.64 (5.82)	1.33 (2.93)	2.03 (4.48)	1.04 (2.29)	*1.18 (2.60)	7.97 (26'2")				
	1 (3'3")					3.18 (7.01)	4.97 (11.0)	2.26 (4.98)	3.45 (7.61)	1.69 (3.73)	2.57 (5.67)	1.29 (2.84)	1.98 (4.37)	1.03 (2.27)	*1.25 (2.76)	7.91 (25'11")				
	0 (Ground)			*3.82 (8.42)	*3.82 (8.42)	3.04 (6.70)	4.80 (10.6)	2.17 (4.78)	3.34 (7.36)	1.63 (3.59)	2.50 (5.51)	1.26 (2.78)	1.95 (4.30)	1.07 (2.36)	*1.36 (3.00)	7.71 (25'4")				
	-1 (-3'3")			4.73 (10.4)	*5.85 (12.9)	2.97 (6.55)	4.72 (10.4)	2.11 (4.65)	3.28 (7.23)	1.59 (3.51)	2.46 (5.42)	1.24 (2.73)	1.93 (4.26)	1.16 (2.56)	*1.53 (3.37)	7.34 (24'1")				
	-2 (-6'7")	*5.18 (11.4)	*5.18 (11.4)	4.76 (10.5)	*7.98 (17.6)	2.96 (6.53)	4.71 (10.4)	2.09 (4.61)	3.26 (7.19)	1.58 (3.48)	2.45 (5.40)			1.33 (2.93)	*1.79 (3.95)	6.78 (22'3")				
	-3 (-9'10")	*7.03 (15.5)	*7.03 (15.5)	4.82 (10.6)	*7.16 (15.8)	2.99 (6.59)	4.74 (10.5)	2.11 (4.65)	3.28 (7.23)					1.60 (3.53)	2.48 (5.47)	5.95 (19'6")				
	-4 (-13'1")	*7.26 (16.0)	*7.26 (16.0)	4.94 (10.9)	*5.85 (12.9)	3.07 (6.77)	*4.61 (10.2)	2.18 (4.81)	3.36 (7.41)											

 Rating over-side or 360 degrees  Rating over-front

Unit: 1 000 kg (1 000 lb)

Conditions	Load point height m (ft in)	Load radius												At max. reach		
		2 (6'7")		3 (9'10")		4 (13'1")		5 (16'5")		6 (19'8")		7 (23'0")				m (ft in)
																
Boom 4.60 m (15'1") Arm 3.01 m (9'11") Bucket PCSA: 0.40 m <sup>3</sup> (0.52 cu yd) CECE: 0.33 m <sup>3</sup> Shoes 500 mm (20")	6 (19'8")									*1.53 (3.37)	*1.53 (3.37)			*1.06 (2.34)	*1.06 (2.34)	7.16 (23'6")
	5 (16'5")									1.97 (4.34)	*2.06 (4.54)			*1.02 (2.25)	*1.02 (2.25)	7.73 (25'4")
	4 (13'1")							*2.26 (4.98)	*2.26 (4.98)	1.94 (4.28)	*2.27 (5.01)	1.43 (3.15)	*1.79 (3.95)	*1.01 (2.23)	*1.01 (2.23)	8.12 (26'8")
	3 (9'10")					*2.46 (5.42)	*2.46 (5.42)	2.59 (5.71)	*2.60 (5.73)	1.88 (4.15)	*2.55 (5.62)	1.41 (3.11)	*2.11 (4.65)	*0.99 (2.18)	*1.02 (2.25)	8.35 (27'5")
	2 (6'7")			*5.51 (12.1)	*5.51 (12.1)	3.53 (7.78)	*4.13 (9.11)	2.46 (5.42)	*3.46 (7.63)	1.80 (3.97)	2.69 (5.93)	1.36 (3.00)	2.06 (4.54)	0.95 (2.09)	*1.06 (2.34)	8.43 (27'8")
	1 (3'3")					3.28 (7.23)	5.08 (11.2)	2.32 (5.12)	3.51 (7.74)	1.72 (3.79)	2.61 (5.76)	1.32 (2.91)	2.01 (4.43)	0.94 (2.07)	*1.11 (2.45)	8.39 (27'6")
	0 (Ground)			*4.80 (10.6)	*4.80 (10.6)	3.09 (6.81)	4.86 (10.7)	2.20 (4.85)	3.38 (7.45)	1.65 (3.64)	2.53 (5.58)	1.27 (2.80)	1.97 (4.34)	0.97 (2.14)	*1.21 (2.67)	8.20 (26'11")
	-1 (-3'3")	*2.60 (5.73)	*2.60 (5.73)	4.72 (10.4)	*5.78 (12.7)	2.99 (6.59)	4.74 (10.5)	2.12 (4.67)	3.30 (7.28)	1.60 (3.53)	2.47 (5.45)	1.24 (2.73)	1.93 (4.26)	1.03 (2.27)	*1.34 (2.95)	7.86 (25'9")
	-2 (-6'7")	*4.54 (10.0)	*4.54 (10.0)	4.71 (10.4)	*7.87 (17.4)	2.95 (6.50)	4.69 (10.3)	2.09 (4.61)	3.25 (7.17)	1.57 (3.46)	2.44 (5.38)	1.23 (2.71)	1.92 (4.23)	1.16 (2.56)	*1.55 (3.42)	7.35 (24'1")
	-3 (-9'10")	*6.88 (15.2)	*6.88 (15.2)	4.75 (10.5)	*7.74 (17.1)	2.95 (6.50)	4.70 (10.4)	2.08 (4.59)	3.25 (7.17)	1.58 (3.48)	2.45 (5.40)			1.40 (3.09)	*1.90 (4.19)	6.61 (21'8")
	-4 (-13'1")	*8.99 (19.8)	*8.99 (19.8)	4.84 (10.7)	*6.68 (14.7)	3.01 (6.64)	4.76 (10.5)	2.13 (4.70)	3.30 (7.28)					1.91 (4.21)	*2.53 (5.58)	5.54 (18'2")

- Notes: 1. Ratings are based on SAE J1097.  
 2. Lifting capacity of the EX Series does not exceed 75% of tipping load with the machine on firm, level ground or 87% of full hydraulic capacity.  
 3. The load point is a hook (not standard equipment) loaded on the back of the bucket.  
 4. \*Indicates load limited by hydraulic capacity.



**EX120**

These specifications are subject to change without notice.

**Hitachi Construction Machinery Co., Ltd.**

Head Office: Nippon Bldg. 6-2, 2-chome, Ohtemachi,  
Chiyoda-ku, Tokyo 100 Japan

Telephone: Tokyo (03) 3245-6377

Facsimile: Tokyo (03) 3246-2609

Telex: J32539 HITACONJ

Cable Address: "TOKHITACHIKENKI"