

EX3500

- Rated engine HP (gross)... 1 312 kW (1 760 HP)
- Operating weight EX3500-2
 - Loading shovel: 330 000 kg (728 000 lb)
 - Backhoe: 330 000 kg (728 000 lb)
- Loading shovel bucket..... PCSA heaped: 18.0 — 25.0 m³
(23.5 — 32.7 cu yd)
- Backhoe bucket PCSA heaped: 17.0 — 25.0 m³
(22.2 — 32.7 cu yd)
CECE heaped: 15.0 — 22.0 m³

Specifications

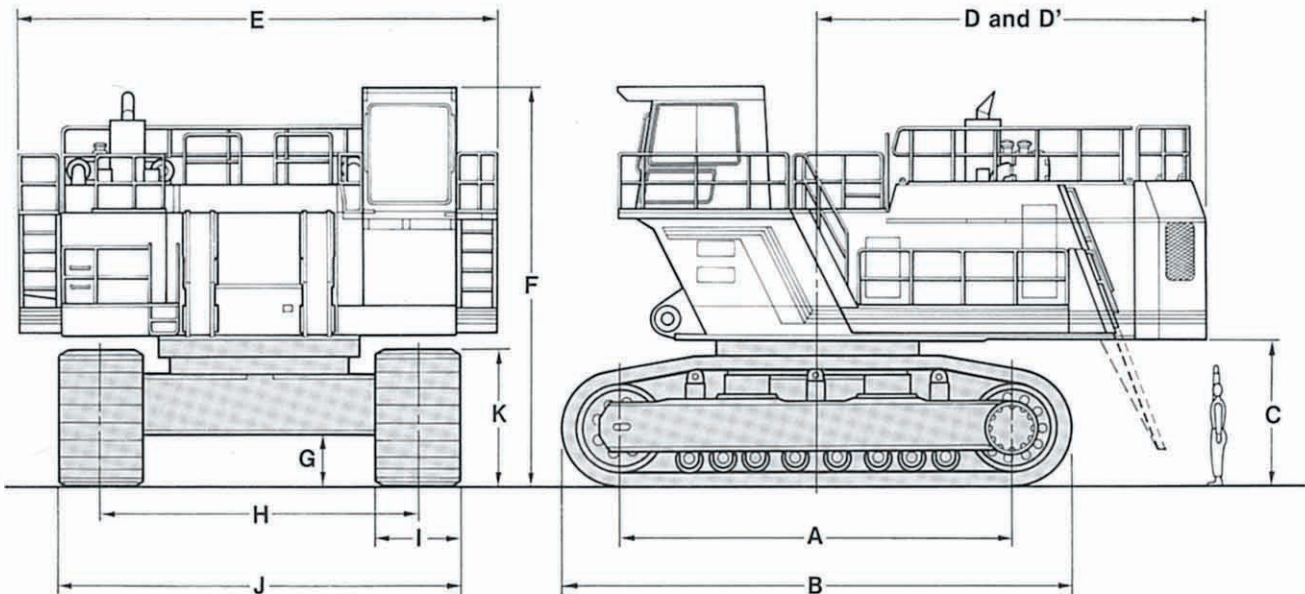

A	Distance between tumbler	6 660 mm (21' 10")
B	Undercarriage length	8 700 mm (28' 6")
C	Counterweight clearance	2 525 mm (8' 3")
D	Rear-end swing radius	6 780 mm (22' 3")
D'	Rear-end length	6 650 mm (21' 10")
E	Overall width	8 240 mm (27' 0")
F	Overall height of cab (with headguard)	6 850 mm (22' 6")
G	Min. ground clearance	900 mm (2' 11")
H	Track gauge	5 500 mm (18' 1")
I	Track shoe width	1 500 mm (4' 11")
J	Undercarriage width	7 000 mm (23' 0")
K	Track height	2 305 mm (7' 7")

TECHNICAL DATA

ENGINE

Model	Cummins KT38-C925
Type	Water-cooled, 4-cycle, V-type, 12-cylinder, turbo-charged, direct injection chamber-type diesel engine
Rated flywheel horsepower (DIN 6271, net)	2 x 609 kW (2 x 829 PS) at 1 800 min ⁻¹ (1 800 rpm)
Rated flywheel horsepower (SAE J1349, net)	2 x 609 kW (2 x 817 HP) at 1 800 min ⁻¹ (1 800 rpm)
Maximum flywheel horsepower (SAE J1349, gross)	2 x 690 kW (2 x 925 HP) at 2 100 min ⁻¹ (2 100 rpm) 2 x 656 kW (2 x 880 HP) at 1 800 min ⁻¹ (1 800 rpm)
Maximum torque	2 x 3 690 N·m (376 kgf·m, 2 700 ft·lbf) at 1 300 min ⁻¹ (1 300 rpm)
Piston displacement	2 x 37.7 l (2 x 2 300 cu in)
Bore and stroke	159 mm x 159 mm (6.3" x 6.3")
Starting system	24 V electric motor
Batteries	6 x 12 V, 6 x 170 AH
Preheating method	Ether aided

HYDRAULIC SYSTEM

Hitachi's ETS (Electronic Total control System) can achieve maximum job efficiency and reduce fuel consumption/noise.

- E-P Control (Computer-aided Engine-Pump Control system) Main pumps regulated by electronic engine-speed sensing control system. Optimum operation mode selectable among 4 power modes depending on type of job.
- OHS (Optimum Hydraulic System) 6 main pumps, 2 independent swing pumps and travel tandem system enable both independent and combined operations of all functions.
- FPS (Fuel-saving Pump System) minimizes energy loss with superior performance in fine control.
- Auto-idling system for saving fuel and reducing noise.
- RMS (Relief-oil Minimizing System) reduces energy losses with minimum oil flow.
- Forced-lubrication and forced-cooling pump drive system.
- TIG (Tungsten Inert Gas) welding pipings.

Main pumps	6 variable-displacement, bent-axis piston pumps for front attachment and travel
Pressure setting	29.4 MPa (300 kgf/cm ² , 4 270 psi)
Max. oil flow	6 x 550 l/min (6 x 145.3 US gpm, 6 x 121.0 Imp gpm)
Swing pumps	2 variable-displacement, bent-axis piston pumps for swinging
Pressure setting	29.4 MPa (300 kgf/cm ² , 4 270 psi)
Max. oil flow	2 x 572 l/min (2 x 151.1 US gpm, 2 x 125.8 Imp gpm)
Pilot pumps	2 gear pumps
Pressure setting	4.4 MPa (45 kgf/cm ² , 640 psi)
Max. oil flow	2 x 50 l/min (2 x 13.2 US gpm, 2 x 11.0 Imp gpm)

Relief Valve Settings

Boom/arm/bucket circuit	29.4 MPa (300 kgf/cm ² , 4 270 psi)
Travel circuit	29.4 MPa (300 kgf/cm ² , 4 270 psi)
Swing circuit	29.4 MPa (300 kgf/cm ² , 4 270 psi)
Pilot circuit	4.4 MPa (45 kgf/cm ² , 640 psi)

Hydraulic Cylinders

High-strength piston rods and tubes adopted. Cylinder cushion mechanisms are provided for boom, arm and bucket cylinders. Boom cylinder ends use self-alignment spherical bearings to avoid bending force. Bucket cylinder of loading shovel is provided with protector.

Cylinder Dimensions

Loading shovel

	Quan.	Bore	Rod diameter
Boom	2	360 mm (14.2")	260 mm (10.2")
Arm	1	300 mm (11.8")	220 mm (8.7")
Bucket	2	280 mm (11.0")	200 mm (7.9")
Dump	2	225 mm (8.9")	130 mm (5.1")
Level	1	360 mm (14.2")	260 mm (10.2")

Backhoe

	Quan.	Bore	Rod diameter
Boom	2	360 mm (14.2")	260 mm (10.2")
Arm	2	300 mm (11.8")	220 mm (8.7")
Bucket	2	250 mm (9.8")	180 mm (7.1")

Hydraulic Filters

All hydraulic circuits have high-quality hydraulic filters for protection against oil contamination and longer life of hydraulic components. 8 full-flow filters of 10 μm are built in return circuit, 8 high-pressure line filters of 80 meshes, 2 drain filters of 10 μm in swing and travel motor drain lines, 3 μm by-pass filter in oil cooler by-pass line, 10 μm pilot filter in pilot control circuit, and suction filters in suction line. These filters are centralized in arrangement for facilitating maintenance.



CONTROLS

2 Implement Levers

Remote-controlled joystick hydraulic servo system. Right lever is for boom and bucket control, left lever for swing and arm control. For loading shovel, 2 pedals provided for opening/closing the bottom dump bucket, Auto-Leveling Crowd Mechanism featuring simplified level crowding is provided as standard.

2 Travel Levers with Pedals

Remote-controlled hydraulic servo system. Independent drive at each track allows counterrotation of tracks.

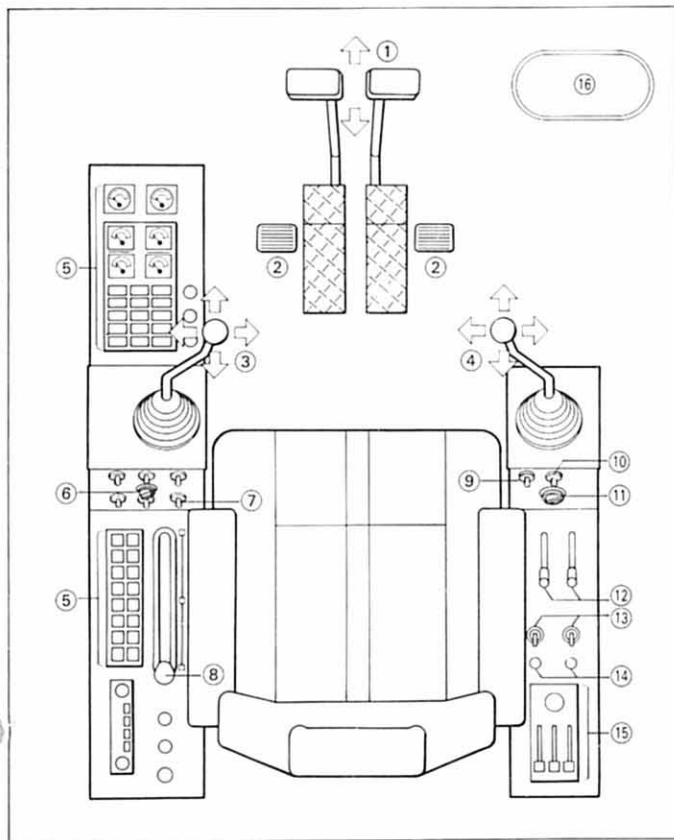

- ① Travel levers with pedals
- ② Bucket open/close pedals (Loading shovel)
- ③ Swing/Arm control lever
- ④ Boom/Bucket control lever
- ⑤ Monitor panel
- ⑥ Power mode switch
- ⑦ Auto-idling switch
- ⑧ Parking/Traveling speed selector lever
- ⑨ Fast filling system switch (option)
- ⑩ Level luffing switch
(circular arc retracting: Loading shovel)
- ⑪ Emergency engine stop switch
- ⑫ Fuel (throttle) lever
- ⑬ Engine starter switch
- ⑭ Ether switch (in cold conditions)
- ⑮ Air conditioner switch (option)
- ⑯ Floor glass



SUPERSTRUCTURE

Revolving Frame

A deep, full-reinforced box section. Heavy-gauge steel plates used for ruggedness. Disassembled into three units of main frame, left and right engine units.

Deck Machinery

Maintenance accessibility is the major feature in the layout of deck machinery. Walkways provide easy access to engines, hydraulic and electrical components.

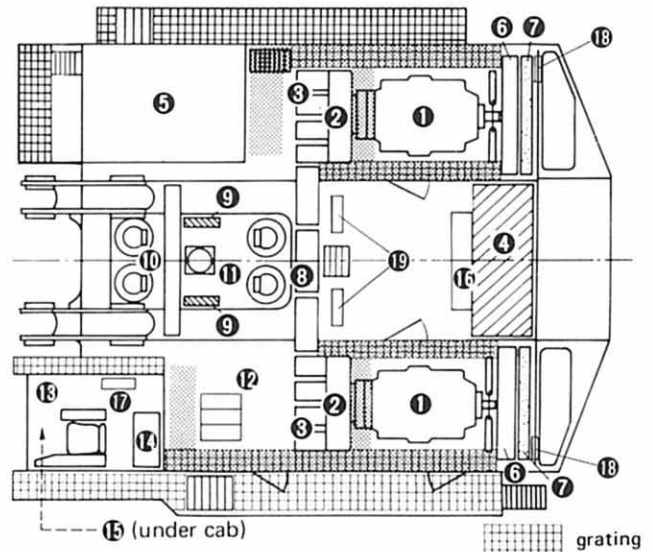

- ① Engine x 2
- ② Pump drive unit x 2
- ③ Hydraulic pump x 8
- ④ Hydraulic oil tank
- ⑤ Fuel tank
- ⑥ Engine radiator x 2
- ⑦ Oil cooler x 2
- ⑧ Main control valve x 3
- ⑨ Swing control valve x 2
- ⑩ Swing device x 4
- ⑪ Center Joint
- ⑫ Batteries
- ⑬ Cab
- ⑭ Air-conditioning unit
- ⑮ Tool box (under cab)
- ⑯ Filters
- ⑰ Cooling unit
- ⑱ Pump drive transmission oil cooler
- ⑲ Hydraulic oil cooler

Swing Mechanism

4 high-torque, axial-piston motors with two-stage planetary gear run in oil. Diametrically-opposed, well-balanced arrangement of 4 swing devices. Swing circle with dirt seals is a heavy-duty, triple-row, cylindrical roller bearing. Induction-hardened internal swing circle gear and pinion immersed in lubricant. Smooth hydraulic swing brake system with lock valve.

Swing speed..... 3.6 min⁻¹ (3.6 rpm)

TECHNICAL DATA

Operator's Cab

Steel construction with integrated, falling-object-protective structure meeting SAE FOPS. Independent, pressurized, 1 600 mm (5' 3") wide, 2 150 mm (7' 1") high, roomy 6.1 m³ (8 cu yd) cab with tinted-glass windows features all-round visibility.

Spring-suspension-type, fully-adjustable seat. Instrument and control panel is in easy range of the operator. Rubber-mounting and sound-proofing structure to reduce noise level and vibration. Air conditioner is optional.

Noise level..... 75 dB (A) in the cab; on max. engine speed under no-load condition

Eye level height..... 6 090 mm (20' 0")



UNDERCARRIAGE

Tracks

Shovel-type undercarriage. Dual-flanged-type bolt linkage for side frame and X-form center frame assures durability. Heavy-duty track frame of all-welded, stress-relieved structure. Top-grade materials used for toughness. Lifetime-lubricated induction-hardened track rollers, idlers and drive tumblers with floating seals. Opposed double-type upper rollers for easy removal of mud. Track shoes of induction-hardened cast steel with triple grousers. Specially heat-treated connection pins. Hydraulic track adjuster provided with N₂ gas accumulator with relief valve. Track adjuster provided with protection device against abnormal tension. Travel motion alarm device.

Shovel-type Undercarriage

Triple grouser track shoes of induction-hardened cast steel

Shoe width..... 1 500 mm (59")

Numbers of Rollers and Shoes on Each Side

Upper rollers..... 3
Lower rollers..... 8
Track shoes..... 38

Traction Device

Each track driven by 2 high-torque, axial piston motors, allowing counterrotation of tracks. 2-stage planetary gear plus spur gears reduction device. Dual-support-type traction device. Parking brake of spring-set/hydraulic-released disc type. This parking brake is manually releasable.

Travel speeds..... High: 0 to 2.4 km/h (1.5 mph)
Low: 0 to 1.8 km/h (1.1 mph)

Maximum traction force 1 760 kN
(179 500 kgf, 395 700 lbf)

Gradeability 30° (60%) continuous

WEIGHTS AND GROUND PRESSURE

Loading Shovel

Equipped with 18.0 m³ (23.5 cu yd; PCSA heaped) bottom dump bucket

Shoe type	Shoe width	Operating weight	Ground pressure
Triple grousers	1 500 mm (59")	330 000 kg (728 000 lb)	144.2 kPa (1.47 kgf/cm ² , 20.9 psi)

Backhoe

Equipped with 10.0 m (32' 10") boom, 5.0 m (16' 5") arm, and 17.0 m³ (22.2 cu yd; PCSA heaped) bucket

Shoe type	Shoe width	Operating weight	Ground pressure
Triple grousers	1 500 mm (59")	330 000 kg (728 000 lb)	144.2 kPa (1.47 kgf/cm ² , 20.9 psi)



SERVICE REFILL CAPACITIES

	liters	US gal	Imp gal
Fuel tank.....	5 000	1 321	1 100
Engine coolant.....	250	66.0	55.0
(per engine)			
Engine oil.....	120	31.7	26.4
(per engine)			
Pump drive.....	25	6.6	5.5
(per engine)			
Swing drive device.....	4 x 75	4 x 19.8	4 x 16.5
(4 units)			
Travel drive device.....	220	58.1	48.4
(each side)			
Hydraulic system.....	4 000	1 057	880
Hydraulic tank.....	1 660	439	365



LOADING SHOVEL ATTACHMENTS

Boom and arm are of all-welded, low-stress, high-tensile strength steel full-box section design. Efficient, automatic level crowding achieved by one-lever control because parallel link mechanism keeps the bucket digging angle constant, and level cylinder circuit maintains the bucket height constant. (Auto-Leveling Crowd Mechanism)

- Buckets with cast-steel lip and replaceable shrouds. 110 kgf/mm² (156 000 psi) tensile strength steel bucket bottom plate
- Both circular arc retracting and horizontal retracting are possible (Loading shovel)
- Dual-support-type boom/arm/bucket pin linkage
- 3 main joint pins for front attachments are free-pin type.
- Pin seals (in all portions) plus O-ring at arm top



WORKING RANGES

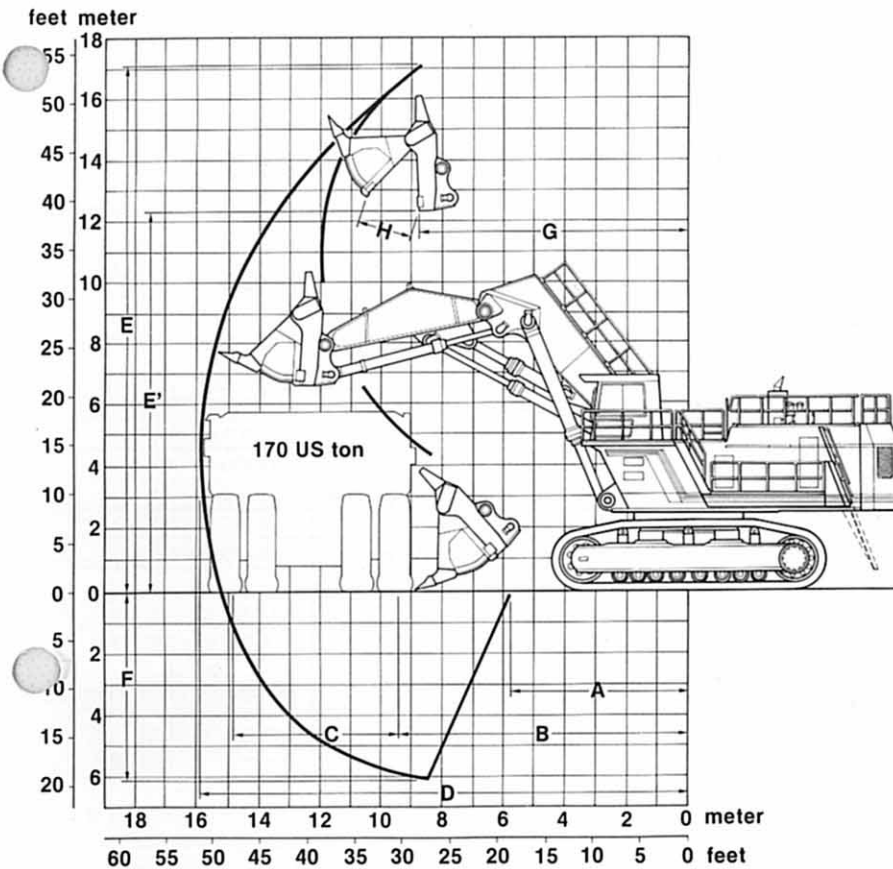

A	Min. digging distance	5 930 mm (19' 5")
B	Min. level crowding distance	9 440 mm (30' 11")
C	Level crowding distance	5 470 mm (17' 11")
D	Max. digging reach	15 810 mm (51' 10")
E	Max. cutting height	17 170 mm (56' 4")
E'	Max. dumping height	12 420 mm (40' 9")
F	Max. digging depth	6 060 mm (19' 11")
G	Working radius at max. dumping height	8 250 mm (27' 1")
H	Max. bucket opening width	2 400 mm (7' 10")
Crowding force	18.0 m ³ (23.5 cu yd)	1 177 kN (120 000 kgf, 264 000 lbf)
	25.0 m ³ (32.7 cu yd)	1 177 kN (120 000 kgf, 264 000 lbf)
Breakout force	18.0 m ³ (23.5 cu yd)	1 030 kN (105 000 kgf, 232 000 lbf)
	25.0 m ³ (32.7 cu yd)	962 kN (98 000 kgf, 216 000 lbf)

Data in are those of the Coal bottom dump type bucket.

Buckets (PCSA heaped)

Capacity	Width	No. of teeth	Weight	Type
18.0 m ³ (23.5 cu yd)	3 950 mm (13' 0")	6	23 800 kg (52 500 lb)	Bottom dump type general purpose bucket
25.0 m ³ (32.7 cu yd)	5 200 mm (17' 1")	6	27 500 kg (60 600 lb)	Bottom dump type coal handling bucket

WORKING RANGES



BACKHOE ATTACHMENTS

Boom and arm are of all-welded, low-stress, full-box section design. Bucket of all-welded, high-strength steel structure.



WORKING RANGES

feet meter

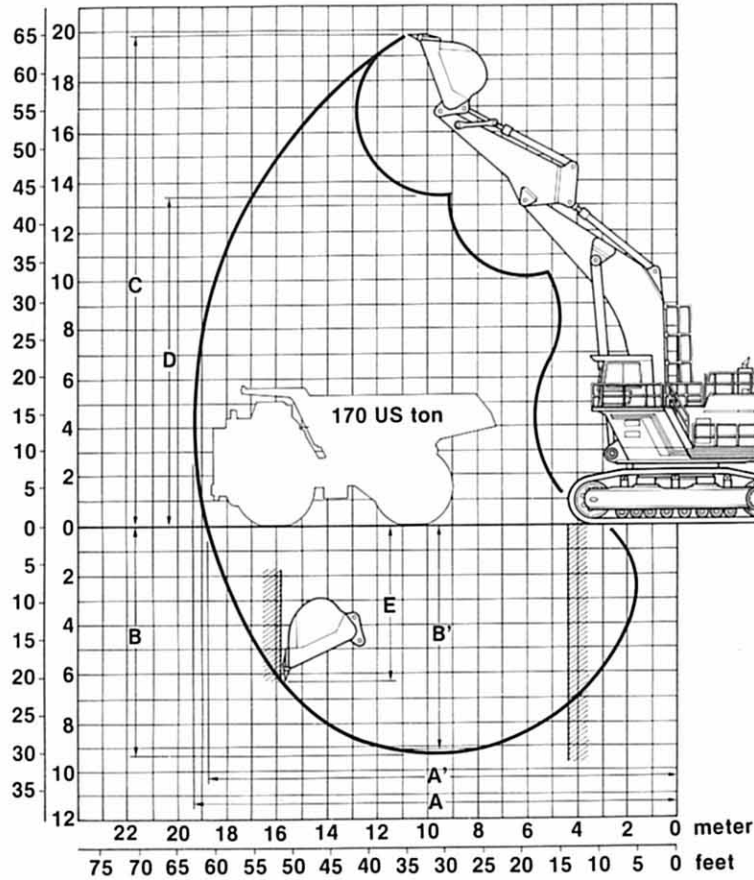

Boom length	10.0 m (32' 10")
Arm length	5.0 m (16' 5")
A Max. digging reach	19 400 mm (63' 8")
A' Max. digging reach (on ground)	18 860 mm (61' 11")
B Max. digging depth	9 340 mm (30' 8")
B' Max. digging depth (8' level)	9 200 mm (30' 2")
C Max. cutting height	19 780 mm (64' 11")
D Max. dumping height	13 300 mm (43' 8")
E Max. vertical wall	6 300 mm (20' 8")
Digging force (arm cylinder)	912 kN (93 000 kgf, 205 000 lbf)
Digging force (bucket cylinder)	932 kN (95 000 kgf, 209 000 lbf)

Buckets

Capacity		Width		No. of teeth	Weight	Recommendation
PCSA heaped	CECE heaped	Without side cutters	With side cutters			10.0 m (32' 10") boom 5.0 m (16' 5") arm
17.0 m ³ (22.2 cu yd)	15.0 m ³ (19.7 cu yd)	3 200 mm (10' 6")	—	5	14 500 kg (32 000 lb)	⊙
25.0 m ³ (32.7 cu yd)	22.0 m ³ (28.8 cu yd)	4 200 mm (13' 9")	—	5	18 000 kg (39 700 lb)	○

⊙ General purpose for materials with density of 2 000 kg/m³ (3 370 lb/cu yd) or less
○ Suitable for materials with density of 1 100 kg/m³ (1 850 lb/cu yd) or less

STANDARD EQUIPMENT *Standard equipment may vary by country, so please consult your Hitachi dealer for details.*

Cab

Reinforced/tinted-glass (bronze color) side windows. Wide-shield, parallel-link-type intermittent wiper. Front window washer. Sliding-type window on left window. Spring-suspension cushion-type, fully-adjustable seat with armrests and headrest. Monitoring/alarm system. Digital clock. AM/FM radio. Defroster. Rearview mirror. Electric double horn. Cigarette lighter and ashtray. Parcel pocket.

Monitoring Alarm System

- Meters
Hourmeter, Engine oil pressure, Engine coolant temperature, Air pressure, Fuel meter
- Warning lamps (Red)
Engine oil pressure, Engine overheat, Hydraulic oil temperature, Pump drive oil pressure, Hydraulic oil level, Pump Contamination, Minimum fuel level (700 l, 185 US gal, 154 Imp gal), Alternator charge, Hydraulic filter clog, Pilot filter clog, Air cleaner clog, Engine room emergency, Ladder, Auto lubrication, Side monitor warning, Valve close, Fast filling, Engine controller
- Pilot lamps (Green)
Engine oil level, Pump drive oil level, Engine coolant level, Swing drive oil level, Hydraulic oil level
- Alarm buzzers
Engine oil pressure, Engine overheat, Hydraulic oil temperature, Pump drive oil pressure, Engine room emergency, Valve close

Lights

6 working lights, 2 access light, 1 cab light

Superstructure

Lockable machine covers. Overall undercover. 40 500 kg (89 300 lb) counterweight. Lockable storage compartment. 3 lamps in engine room and storage compartment (under the cab). Pneumatic grease gun with hose reel. Hold-in-type ladder with spring-type balancer. All-pneumatic instruments centralized on panel under superstructure. Control valves with main relief valves and overload relief valves. Accumulator for pilot circuit.

Undercarriage

Parking brake is spring-set/hydraulic-released disc type. Hydraulic track adjuster provided with N₂ gas accumulator with relief valve. Travel motion alarm device. Lifetime-lubricated rollers, idler, and drive tumbler. Travel motor cover.

Miscellaneous

Standard tool kit. Grated catwalks and stairs. Handrails. Heavy-duty-type air cleaner with evacuator valve. Radiator reserve tank.

OPTIONAL EQUIPMENT *Optional equipment may vary by country, so please consult your Hitachi dealer for details.*

- Auto-lubrication system (Lincoln) for front-attachment pins, swing bearing, and center joint
- Fast-filling system (Wiggins) for fuel, hydraulic oil, coolant swing device oil, and engine oil
- Auto bucket level raise system (microcomputed control)
- Air conditioner with defroster, damper, and filter
- Cooling unit
- Seat belt

TRANSPORTATION

- Easily assembled owing to local assembling system requiring no welding.
- Overall width of below 3 500 mm (11'6") during transportation.

SUPERSTRUCTURE

Unit: mm (ft in)

Cab; 880 kg (1 940 lb)

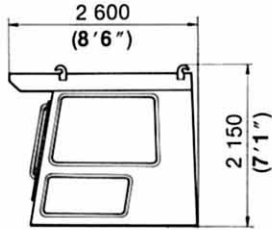

Width; 1 600 (5'3")

Operator's seat; 55 kg (120 lb)

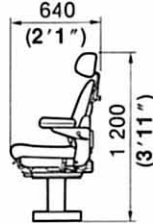

Width; 490 (1'7")

Stays; 46 kg (100 lb) x 3

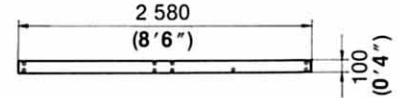

Width; 100 (0'4")

Covers; 61 kg (130 lb) x 2

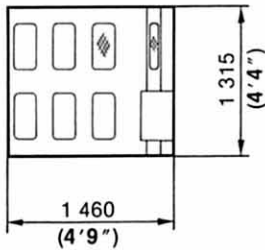

Width; 480 (1'7")

Covers; 38 kg (80 lb) x 2

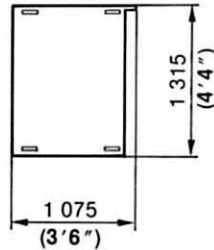

Width; 40 (0'2")

Main frame assembly; 45 440 kg (100 200 lb)

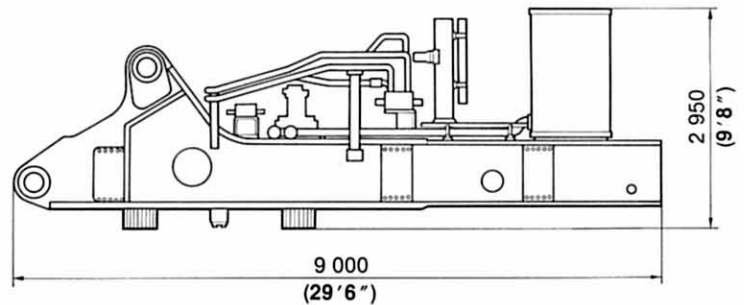

Width; 3 490 (11'5")

Engine unit (left); 15 700 kg (34 600 lb)

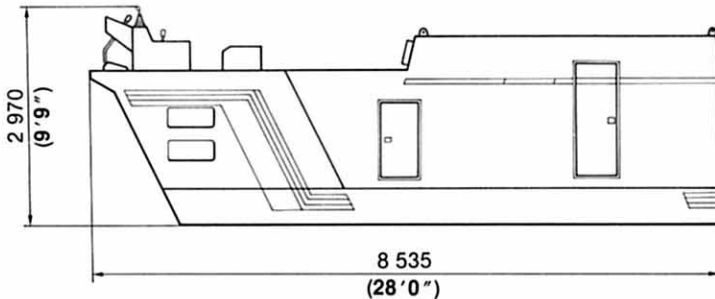

Width; 2 155 (7'1")

Engine unit (right); 17 300 kg (38 100 lb)

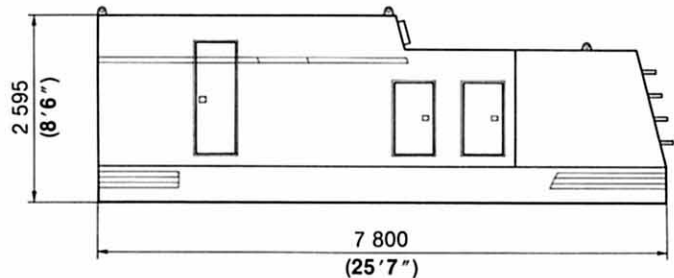

Width; 2 155 (7'1")

Handrail; 50 kg (110 lb)

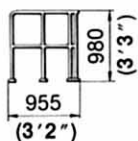

Width; 6 740 (22'1")

Counterweight; 40 500 kg (89 300 lb)

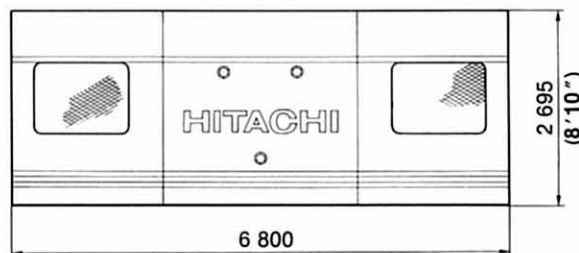

Width; 1 200 (3'11")

Covers; 63 kg (140 lb) x 2

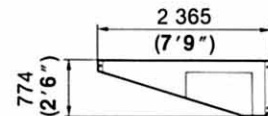

Width; 155 (0'6")

CATWALKS

Unit: mm (ft in)

Step; 258 kg (570 lb)

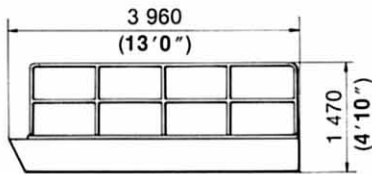

Width; 700 (2'4")

Ladder; 104 kg (230 lb)

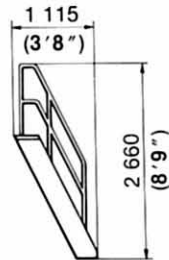

Width; 700 (2'4")

Handrails; 40 kg (90 lb) x 2

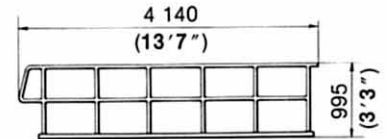

Width; 70 (0'3")

Step; 123 kg (270 lb)

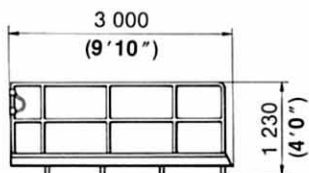

Width; 900 (2'11")

Handrails

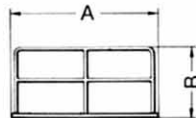

Step; 71 kg (155 lb)

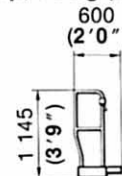

Width; 2400 (7'10")

Ladder; 240 kg (530 lb)

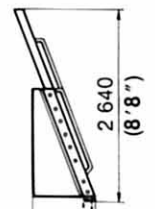

Covers; 36 kg (80 lb) x 2

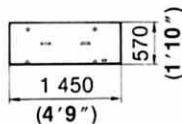

Height; 45 (0'2")

	Length		Width	Weight
	A	B		
Handrail a	1 470 (4'10")	995 (3'3")	70 (0'3")	68kg (150 lb)
.. b	1 025 (3'4")	1 130 (3'8")	325 (1'1")	18kg (40 lb)
.. c	2 050 (6'9")	995 (3'3")	70 (0'3")	19kg (42 lb)
.. d	2 400 (7'10")	990 (3'3")	310 (1'0")	22kg (49 lb)

Step; 132 kg (290 lb)

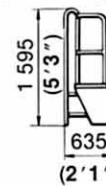

(2'1")

Width; 2050 (6'9")

Width; 650 (2'2")

Step; 320 kg (710 lb)

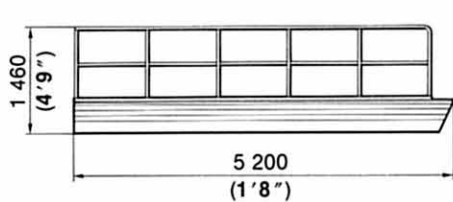

Width; 700 (2'4")

Step; 120 kg (260 lb)

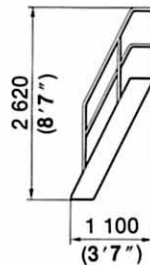

Width; 700 (2'4")

Handrails; 10 kg (20 lb)

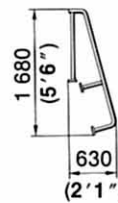

Width; 60 (0'2")

Handrails; 10 kg (20 lb)

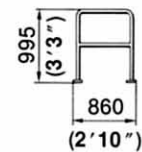

Width; 70 (0'3")

Handrail; 16 kg (35 lb)

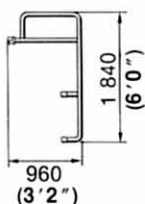

Width; 200 (0'8")

Handrail; 30 kg (70 lb)

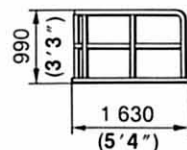

Width; 1250 (4'1")

Mufflers; 110 kg (240 lb) x 2

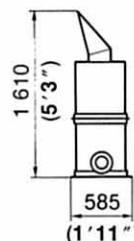

Width; 590 (1'1")

Muffler covers; 41 kg (90 lb) x 2

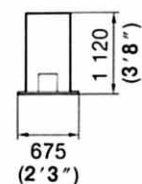

Width; 1176 (3'10")

TRANSPORTATION

Unit: mm (ft in)

Pipes; 6 kg (10 lb) x 4

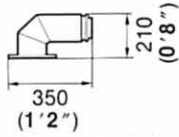

Width; 215 (0'8")

Rubber hoses; 1.4 kg (3 lb) x 4

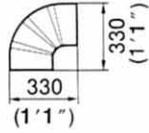

Width; 235 (0'9")

Covers; 23 kg (50 lb) x 2

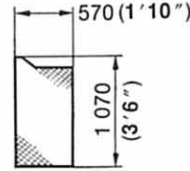

Width; 43 (0'2")

Covers; 27 kg (60 lb)

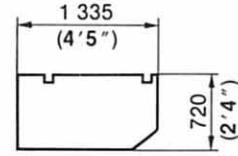

Width; 90 (0'4")

Air cleaners; 66 kg (150 lb) x 2

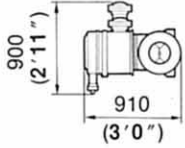

Width; 750 (2'6")

Covers; 5 kg (10 lb) x 2

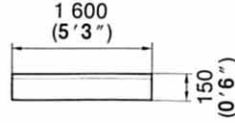

Width; 80 (0'3")

Covers; 4.5 kg (10 lb) x 2

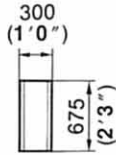

Width; 210 (0'8")

Covers; 6 kg (13 lb) x 2

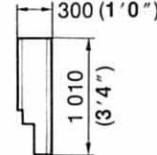

Width; 210 (0'8")

Stopper; 18 kg (40 lb)

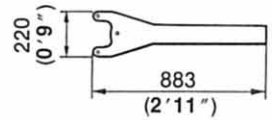

Width; 25 (0'1")

UNDERCARRIAGE

Track center frame assembly; 31 300 kg

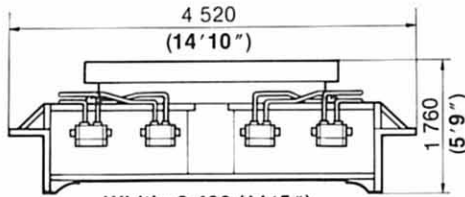

Width; 3 490 (11'5")

Track side frame assembly; 42 900 kg (94 600 lb) x 2

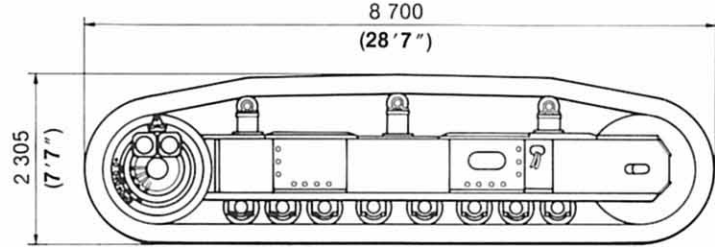

Width; 2 425 (7'11")

Motor covers; 90 kg (200 lb)

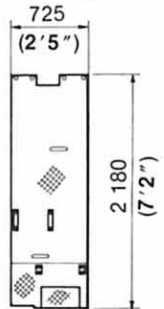

116 kg (255 lb)

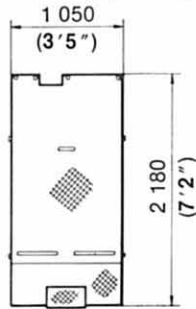

78 kg (170 lb)

112 kg (250 lb)

Motor cover stay; 92 kg (200 lb)

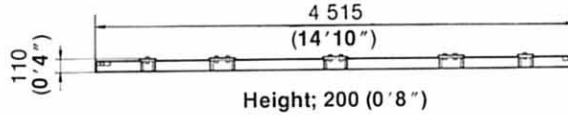

Height; 200 (0'8")

Step; 8 kg (18 lb)

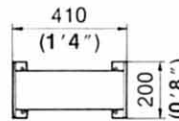

Width; 325 (1'2")

Ladder; 16 kg (35 lb)

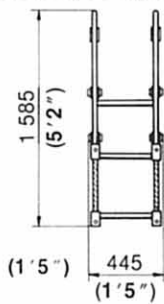

LOADER ATTACHMENT

Unit: mm (ft in)

Handrails; 31 kg (70 lb) x 2

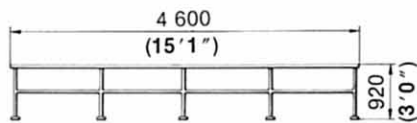

Width; 50 (0'2")

Boom assembly; 35 100 kg (77 400 lb)

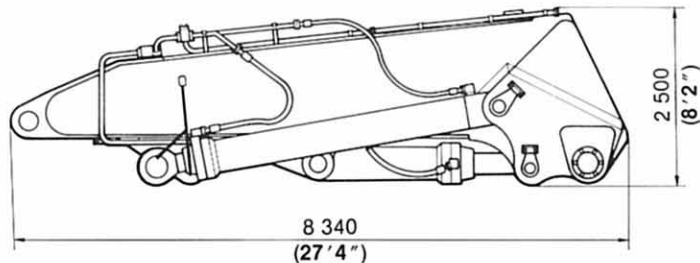

Width; 2 600 (8'6")

Unit: mm (ft in)

Arm cylinder; 2 865 kg (6 320 lb)

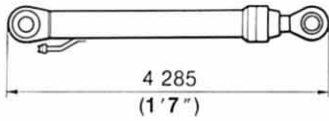

Bucket cylinders; 2 400 kg (5 290 lb) x 2

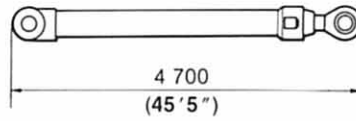

Arm assembly; 13 200 kg (29 100 lb)

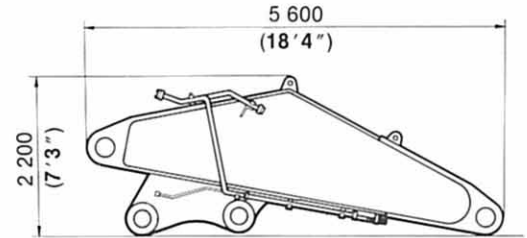

Bucket assembly
with bucket points; 24 000 kg (52 900 lb)
Capacity; 18.0 m³
(23.5 cu yd; PCSA heaped)

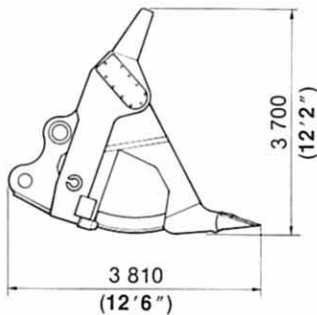

Width; 4 170 (13'8")

Bucket assembly
without bucket points; 28 000 kg
(61 700 lb)

Capacity; 25.0 m³
(32.7 cu yd; PCSA heaped)

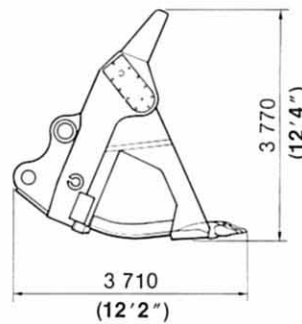

Width; 5 400 (17'9")

Points; 66 kg (150 lb) x 6

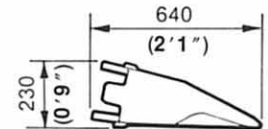

Width; 210 (0'8")

BACKHOE ATTACHMENT

Boom assembly; 45 500 kg (100 300 lb)

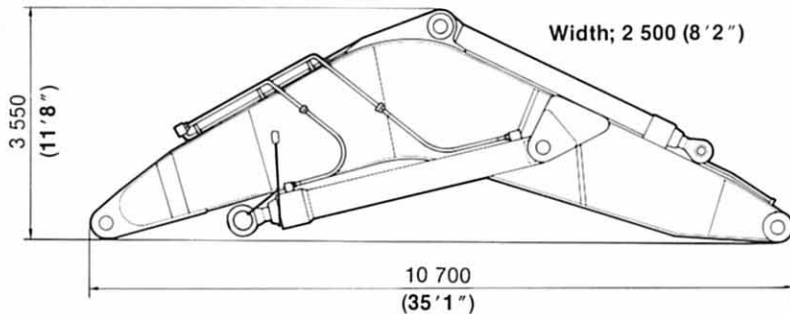

Width; 2 500 (8'2")

Arm assembly; 20 300 kg (44 800 lb)

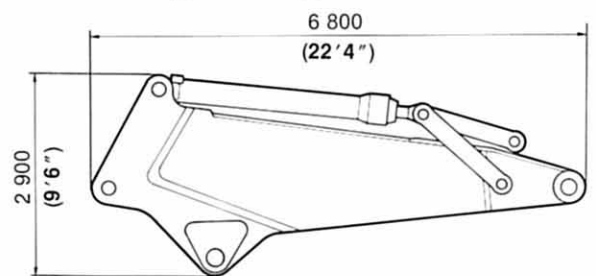

Width; 1 700 (5'7")

Bucket assembly; 16 000 kg (35 300 lb)

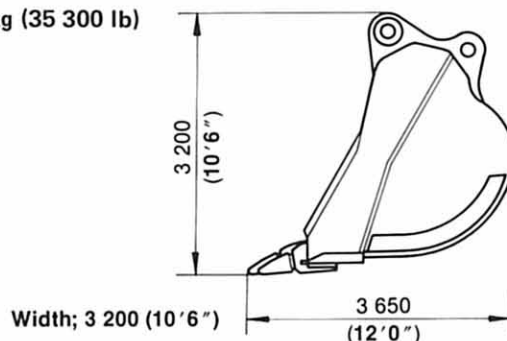

Width; 3 200 (10'6")

LIFTING CAPACITIES

SuperEX

METRIC MEASURE

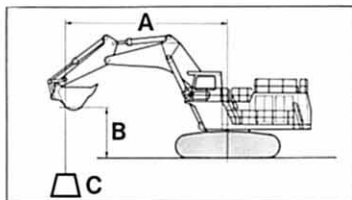

A: Load radius
B: Load point height
C: Lifting capacity

Rating over-side or 360 degrees Rating over-front

Unit: 1 000 kg

Conditions	Load point height m	Load radius										At max. reach				
		8 m		10 m		12 m		14 m		15 m		16 m				@ m
Boom 10.0 m Arm 5.0 m Bucket PCSA: 17.0 m ³ CECE: 15.0 m ³ Shoes 1 500 mm	13							*26.8	*26.8					*14.1	*14.1	17.3
	12							*31.3	*31.3					*13.5	*13.5	17.8
	10					*33.1	*33.1	*35.5	*35.5	*30.9	*30.9			*12.7	*12.7	18.5
	8					*34.3	*34.3	*37.0	*37.0	*35.8	*35.8	*27.4	*27.4	*12.3	*12.3	18.9
	6			*43.9	*43.9	*42.1	*42.1	*41.3	*41.3	*39.6	*39.6	*34.4	*34.4	*12.2	*12.2	19.1
	4					60.1	*62.9	45.0	*49.9	39.2	*45.4	34.2	*39.0	*12.5	*12.5	18.9
	2					56.5	*64.4	42.8	*51.7	37.5	*46.5	33.0	*41.5	*13.2	*13.2	18.5
	0 (ground)			73.8	*80.6	54.0	*63.0	41.2	*49.8	36.3	*44.1	32.2	38.1	*14.4	*14.4	17.8
	-2			72.5	*73.3	52.8	*58.0	40.4	*45.0	35.8	*38.5	*28.3	*28.3	*13.6	*13.6	16.8
	-4	*72.1	*72.1	*61.1	*61.1	*48.5	*48.5	*35.1	*35.1	*25.3	*25.3					
-5	*61.2	*61.2	*52.9	*52.9	*41.4	*41.4	*26.6	*26.6								

ENGLISH MEASURE

Unit: 1 000 lb

Conditions	Load point height ft	Load radius										At max. reach				
		25 ft		30 ft		35 ft		40 ft		45 ft		50 ft				@ ft in
Boom 32' 10" Arm 16' 5" Bucket PCSA: 22.2 cu yd Shoes 59"	40							*77.4	*77.4	*71.1	*71.1			*30.1	*30.1	58' 1"
	30							*73.8	*73.8	*79.2	*79.2	*70.0	*70.0	*27.5	*27.5	61' 5"
	25					*70.2	*70.2	*78.3	*78.3	*82.6	*82.6	*78.5	*78.5	*27.0	*27.0	62' 3"
	20					*92.2	*92.2	*91.6	*91.6	*90.8	*90.8	*85.2	*85.2	*26.9	*26.9	62' 7"
	15					*153.1	*153.1	*118.9	*118.9	104.9	*105.5	84.7	*93.6	*27.3	*27.3	62' 4"
	10					157.5	*165.9	124.9	*138.1	100.6	*117.6	81.9	101.1	*28.2	*28.2	61' 8"
	5					150.6	*167.3	119.8	*138.8	97.0	117.0	79.4	99.0	*29.7	*29.7	60' 5"
	0 (ground)					145.9	*163.4	116.0	*135.8	94.2	113.6	77.6	94.2	*31.9	*31.9	58' 6"
	-5			*183.5	*183.5	143.3	*153.9	113.7	*128.3	92.5	*106.4	76.8	*85.2	*34.3	*34.3	56' 0"
	-10			*162.7	*162.7	*138.5	*138.5	*113.0	*115.5	92.1	*93.8	*68.1	*68.1			
-15	*147.7	*147.7	*135.0	*135.0	*116.3	*116.3	*95.8	*95.8	*72.9	*72.9						

Note: 1. Ratings are based on SAE J1097.
2. Lifting capacity of the EX Series does not exceed 75% of tipping load with the machine on firm, level ground or 87% of full hydraulic capacity.
3. The load point is a hook (not standard equipment) loaded on the back of the bucket.
4. *Indicates load limited by hydraulic capacity.

These specifications are subject to change without notice.

Hitachi Construction Machinery Co., Ltd.

Head Office: Nippon Bldg. 6-2, 2-chome, Ohtemachi,
Chiyoda-ku, Tokyo 100 Japan

Telephone: Tokyo (03) 3245-6361

Facsimile: Tokyo (03) 3246-2606

Telex: J32539 HITACONJ

Cable Address: "TOKHITACHIKENKI"