

EH1100-3

HITACHI

*EH*  
*1100*



## Dump Truck

- **Nominal Payload with Standard Equipment** : 59.0 tonnes (65.0 tons)
- **Maximum GMW** : 110 677 kg
- **Engine** : MTU Detroit Diesel 12 V Series 2000  
Rated Power 567 kW (760 HP)

# Engineered for Performance, Designed for Comfort, and Built to Last.

## Hitachi Technologies

Hitachi Trucks, like Hitachi Excavators are designed and manufactured using cutting edge technology. Trucks designed by Hitachi using Hitachi Electronic devices result in great electrical system reliability, efficiency and control.

## High-Powered Engine

Strong, reliable power is provided by the MTU Detroit Diesel 12 V Series 2000 diesel engine. This engine features the latest in diesel engine development providing low fuel consumption while meeting the emission regulations of U.S. EPA Tier 2 and EU Stage II.

## Long Frame Life

Frame rails are tapered from front to rear to distribute the load evenly over the entire length of the chassis. In place of castings, cold rolled steel is used as it is known to be more homogeneous and easier to repair. Weld joints are oriented longitudinally to the principal flow of stress for strength and long life. Proven design and manufacturing methods with state-of-the-art ultrasonic testing ensure a quality product.

## Unique Body Design

The single sloped floor evenly distributes material shedding during dumping. A continuously exhaust-heated body reduces carry-back of material, and muffles exhaust. Horizontal floor and side rail stiffeners distribute load shocks evenly over the entire body length, minimizing stress concentrations in any one area. Closely spaced floor stiffeners reduce wear due to impact loading.

## Well Matched: EH1100-3 & Excavators

Excavator	ZX870LCH-3		EX1200-5D (BH)		EX1200-5D (LD)	EX1900-5 (BH)
Boom	7.1 m - BE Boom	8.4 m - H Boom	9.1 m - Boom	7.55 m - BE Boom	—	11.8 m - Boom
Arm	2.95 m - BE Arm	3.7 m - H Arm	3.4 m - Arm	3.4 m - BE Arm	—	5.5 m - Arm
Bucket Capacity (SAE, PCSA heaped)	4.3 m <sup>3</sup>	3.5 m <sup>3</sup>	5.0 m <sup>3</sup>	6.5 m <sup>3</sup>	6.5 m <sup>3</sup>	4.8 m <sup>3</sup>
Passes	8	10	7	5	5	7



# Rugged Construction

## Technologically Advanced

The EH1100-3 is designed to develop low cycle times and extra efficiency in the heavy duty applications of quarrying and mining. This truck provides low operating costs, unparalleled productivity and overall quality through its superior structure and systems designs.

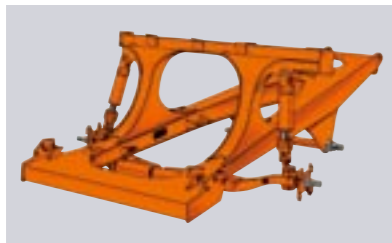

## Robust Frame

Full fabricated box section main rails with section height tapered from rear to front. Wider at the rear to support the loads and narrower at the front to allow for engine accessibility. One piece top and bottom flanges that eliminate cross member tie in joints and provide a large exposed center area for access to major components. Large radii at frame junctions are blended and ground to minimize stress concentrations. Weld joints are oriented longitudinally to the principal flow of stress for greater durability and more strength. Frame utilizes 345 MPa yield high strength low alloy steel that is robotically welded to ensure consistently high quality welds.

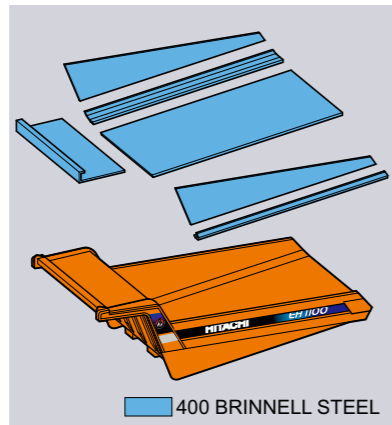

## Reinforced Body

Built for quarry and mining applications, the EH1100-3 body uses a 18 mm floor plate and 8 mm side plates made of 400 BHN high-tensile steel. This provides high resistance to wear and impact. A low loading height and large target area allow easy, quick loading by a variety of loading tools.

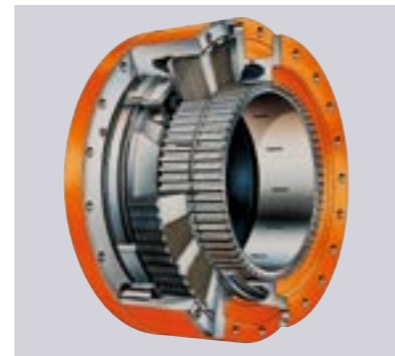

## Fully Hydraulic Brake

The fully hydraulic brakes feature high reliability, durability and serviceability. Optimum brake force yields maximum available braking under tough ground conditions for best control. Unique variable front to rear brake proportioning maximizes stop performance under slippery road conditions.



# Ease of Operation



## HI-TECH ROPS / FOPS Cab

The new Hi-TECH (Hitachi Technology) ROPS/FOPS Cab features a center integrated, "flat panel" style dashboard that positions the display and controls within close view of the road ahead. The cab uses double-wall construction and a 3-point rubber iso-mount to absorb shocks and noise. The new high powered heater provides ample BTU's for all environments and working conditions. The new Hitachi controller, built by Hitachi and also used in excavators, will perform its function of processing input and output information with reliability during the most rigorous haul cycle.



## Auto-Lubrication System (Optional)

A pump fed system automatically applies grease to lube points via plumbing. The lubricant is automatically delivered in time controlled and metered quantities to all connected lube points in the system.



Auto Lubricator Controller

## Superior Suspension

The Hitachi ACCU-TRAC suspension system delivers excellent maneuverability, even at higher speeds. The trailing arm layout offers greater ease of servicing while improving truck performance compared to suspended king-pin designs. The pivot mounting of the trailing arm design allows only axial input to the strut and allows wheel movement to the vertical plane only.

### Features:

- Lateral forces that act on the front wheels are minimized, resulting in reduced tire scuffing.
- Dynamic friction (side-wall force) within the strut is low due to the features of the ACCU-TRAC design, allowing the use of a lighter strut engineered to a smaller diameter and longer stroke.
- The necessary frame bulk (horse-collar structure) needed to mount a suspended king-pin is non-existent.
- The elimination of the "horse-collar" member provides greater engine access.
- The NEOCON strut used with the ACCU-TRAC suspension, improves operator and component isolation, provides better hauler stability and predictable operational control.
- Locating the king-pin close to the wheel assembly and at a slight angle results in low "Dry Park Steering" effort.
- Development of the compressible media, NEOCON-E™ fluid (proprietary, silicone based, environmentally friendly) for use in the suspension strut with Helium gas, results in an improved energy absorption (isolation) system and an improved energy release (stability) system that responds favorably whether traveling empty or with payload in a wide range of ambient temperatures.

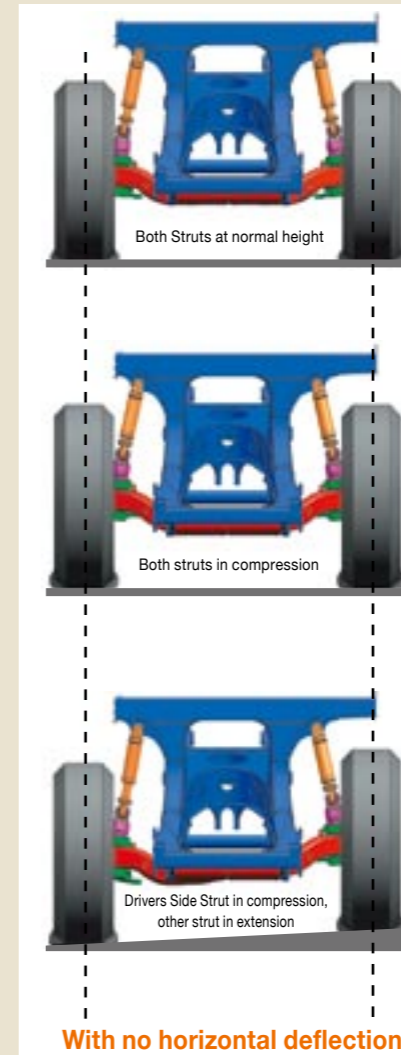

### Spindle

Each spindle is controlled by a hydraulic steering cylinder, rotates around the king-pin and the outer end of the trailing arm to position the wheels for steering. The spindles are attached by one tie-rod.

### King-Pin

Retains the spindle to the trailing arm. Spindle rotates around the king-pin, which is locked in position. The Neocon-E strut attaches to the top.

### Trailing Arm

Main suspension member to which other suspension components are attached. The trailing arms hinge on a torque tube that is clamped to the front of the frame.

### Neocon Strut

The energy absorption and release component of the ACCU-TRAC suspension system. Pinned to ball bushings at the frame and at the top of the king-pin to prevent bending movements from transferring to the strut. Receives only axial input.

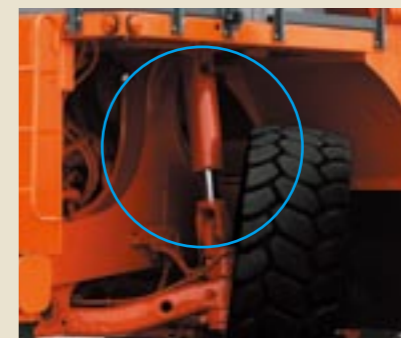

The ACCU-TRAC suspension design allows the front struts to be removed and installed without removing the trailing arms, brakes or tires. This relates to fewer tools and less labour required to perform the repair, which aims to reduce the amount of hauler downtime, increasing productivity.

### Trailing Arm Suspension (Front)

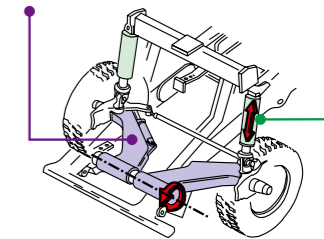

### NEOCON Strut (Front/Rear)

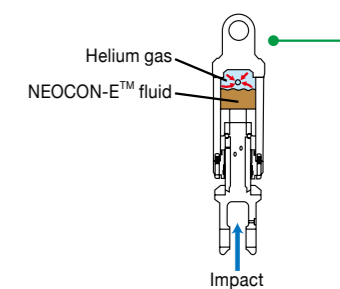

## ENGINE

Model.....	MTU Detroit Diesel 12 V Series 2000
Type .....	4 Cycle, V12, diesel injection
Emission Certification ..	U.S. E.P.A Tier 2, E.U. Stage II
Aspiration.....	Turbocharged / Aftercooled
Rated Power	
SAE J1995, gross ..	567 kW (760 HP) at 2 100 min <sup>-1</sup> (rpm)
SAE J1349, net.....	520 kW (698 HP) at 2 100 min <sup>-1</sup> (rpm)
ISO 9249, net.....	520 kW (698 HP) at 2 100 min <sup>-1</sup> (rpm)
EEC 80/1269, net ..	520 kW (698 HP) at 2 100 min <sup>-1</sup> (rpm)
Maximum Torque.....	3 091 N·m (315 kgf·m) at 1 350 min <sup>-1</sup> (rpm)
Piston Displacement...	23.9 L
Bore and Stroke.....	130 x 150 mm
Torque Rise .....	20 %
Starting .....	Electric

## TRANSMISSION

Model.....	Allison H6610A
Design.....	Fully automatic, planetary type with integral lock-up converter
Mounting/Position .....	Remote from engine and rear axle for serviceability
Ranges .....	6 forward, 2 reverse
Control.....	Allison CEC2 electronics shift system with SEM (Shift Energy Management)

### Maximum Speeds @Governed Engine Speed with standard 24.00R35(\*\*)E4 tires

		Standard Final Drive 3.64 : 1
Differential Planetary		5.80 : 1
Gear	Ratio	km/h
1	4.00	9.7
2	2.68	14.5
3	2.01	19.3
4	1.35	28.8
5	1.00	38.8
6	0.67	57.9
R1	5.15	7.6
R2	3.46	11.3

## DRIVE AXLE

Model Differential.....	2354
Axle Design .....	Full floating axle shafts using a model 2354 differential and single reduction planetaries at each wheel
Traction Control.....	An optional electronic feature that includes the Electronic Downhill Speed Control feature

### Differential and Final Drive Ratios

Ratios	Standard
Differential	3.64 : 1
Planetary	5.80 : 1
Total Reduction	21.11 : 1
<b>Maximum Speeds</b> with 24.00R35 tires	57.9 km/h

## TIRES

Front .....	24.00 R35(**) (Standard)
Rear .....	24.00 R35(**) (Standard)
Rim Width .....	432 mm (17 in)
Optional tires and tread patterns may be available.	

Certain job conditions may require higher TKPH(TMPH) in order to maintain maximum production. Hitachi recommends evaluating the job conditions and consulting the tire manufacturer to make proper tire selection.

## ELECTRICAL SYSTEM

Twenty-four volt starting, lighting and accessories system. Seventy-five ampere alternator with integral transistorized voltage regulator. Two 12 V heavy duty batteries capable of 1300 cold cranking amps, each, at -17 degree C (0 degree F). A Hitachi solid state reprogrammable controller controls and monitors hauler systems, provides output information to control gauges and lights and incorporates connections for diagnostic tools.

## BODY CAPACITY

	m <sup>3</sup>
Struck (SAE)	28.2
Heap 3 : 1	35.2
Heap 2 : 1 (SAE)	38.7

Body capacity and payload subject to change based on customer specific material density, options and application.

## WEIGHTS (Approximate)

Weights given are for standard options, standard body and tires. Net machine weight changes will directly affect the payload. Material density will determine body volume figures.

	kg
Chassis with Hoist	33 325
Body	12 488
Net Machine Weight	45 813
Maximum GMW* with Std. Tires [24.00 R35 (**) E4]	110 677
*This specification is not to be exceeded and includes all options, customer installed attachments, 50% fuel, with operator and payload.	
Payload with Standard Equipment	64.9 tonnes (71.5 tons)

Note: Nominal Payload on front cover shows 100/110 of Payload with Standard Equipment.

### Major Options

The following list of options (not limited to) is an example of what will change the net machine weight.

- Automatic Fire Suppression
- Body Liner, heavy duty and partial
- Deck Mounted Muffler

Weight Distribution	Front	Rear
Empty	50 %	50 %
Loaded	34 %	66 %

## STEERING SYSTEM

Closed-center, full-time hydrostatic steering system using two double-acting cylinders, pressure limit with unload piston pump and brake actuation/steering system reservoir. An accumulator provides supplementary steering in accordance with SAE J1511 and ISO 5010. The Operators steering wheel offers 35 degrees of tilt and 57.2 mm of tilt travel.

Steering Angle	39 degrees
Turning Diameter: (SAE)	19.28 m
Steering Pump Output*	95.7 L/min
System Pressure	18.9 MPa
*Steering Pump Output (at 2 100 min <sup>-1</sup> (rpm))	

## HYDRAULIC SYSTEM

Two 2-stage, double-acting cylinders, with cushioning in retraction, inverted and outboard mounted. Separate Hoist/Brake Cooling reservoir and independent tandem gear pump. Control valve mounted on reservoir.

Body Raise Travel	60 degrees
Body Raise Time (at 2100 min <sup>-1</sup> (rpm))	12.0 s
Body Down Time (at idle)	16.0 s
Brake Cooling Pump Output (at 2100 min <sup>-1</sup> (rpm))	176 L/min
Hoist Pump Output (at 2100 min <sup>-1</sup> (rpm))	468 L/min
System Relief Pressure*	17.2 MPa
*System Relief Pressure (Hoist)	

## BRAKE SYSTEM

Brake system complies with SAE J1473/ISO 3450.

All-hydraulic actuated braking system providing precise braking control and quick system response. The Hitachi brake controller has a unique variable front to rear brake proportioning that maximizes the stopping performance under all road conditions.

### Service

All-hydraulic actuated front disc brakes and rear oil-cooled wet disc.

### WET DISC BRAKE

The Hitachi wet disc brake is engineered for long service life even in the most extreme environments. The wet disc brakes are located on the rear axle and provide service braking, secondary braking, and retarding. The brakes are a multi-plate design, and continuously oil-cooled. The sealed design protects against environmental contamination for prolonged service life. The wet disc brake is designed with automatic retraction to prevent drag. Separate pedals activate the service braking and retarding functions.

### Front Axle - Dry Disc

Disc Diameter Each (2 discs/axle)	686 cm
Brake Surface Area Per Axle	4 129 cm <sup>2</sup>
Lining Area Per Axle	2 787 cm <sup>2</sup>
Brake Pressure (Max.)	15.8 MPa

### Rear Axle - Oil-Cooled Wet Disc

Brake Surface Area Per Axle	59 616 cm <sup>2</sup>
Brake Pressure (Max.)	4.8 MPa

### Secondary

Two independent circuits within the service brake system provide back-up stopping capability. System is manually or automatically applied to stop machine within prescribed braking distance.

### Parking

Dry disc mounted on differential input shaft. Controlled by a toggle switch on the dash. Automatically applied if brake hydraulic pressure is lost.

Size (Diameter)	597 mm
-----------------	--------

## Retarder

Foot-operated valve controls all-hydraulic actuation of oil-cooled wet disc brakes on rear axle. System provides modulated pressure to rear brakes for constant speed control.

Continuous	656 kW	(880 HP)
Intermittent	1 268 kW	(1 700 HP)

## Load/Dump Brake Apply

Through activation of a switch by the operator, a solenoid is energized, sending full brake pressure to apply the rear Wet Disc brakes. For use during the load and dump cycles.

## HI-TECH ROPS / FOPS CAB

### Hi-Tech ROPS / FOPS Cab

ROPS complies with ISO 3471 and SAE J1040-May 94. FOPS complies with ISO 3449. Double wall construction of 11 gauge inner and outer steel panels, lends itself to a more structurally sound cab. Multiple layered floor mats act to absorb sound and control interior temperature.

A properly maintained cab from Hitachi, tested with doors and windows closed per work cycle procedures in ISO 6394: 1998 (dBA), results in an operator sound exposure Leq (Equivalent Sound Level) of 81 dB(A).

A three-point rubber iso-mount arrangement to the deck surface minimizes vibration to the operator compartment.

### Excellent Serviceability

A removable front panel allows easy access to service brake valves, retarder valve and heater assembly. A removable cover located behind the operators seat provides easy access to the Transmission Contoller (TCU), Central Contoller (CCU) and all electrical junction points.

### Comfort and Ease of Operation

A flat panel style dashboard positions controls within easy reach and visual contact. A full complement of easy-to-read gauges, automobile type monitor with warning system, a spacious environment, multiple position adjustable seat, tilt/telescopic steering wheel, filtered cab ventilation and door locks all contribute to operator convenience, control and comfort.

## SUSPENSION

### Front and Rear Suspension

For years, Hitachi haulers have enjoyed an industry-wide reputation for superior suspension systems. That experience and knowledge has now been pushed to the next level, to develop the truly advanced ACCU-TRAC suspension for the EH1100-3. To make sure it was fine tuned to the limit, Lotus Engineering, a world leader in suspension design, was contracted to review the entire system to assure optimized ride and handling performance.

The ACCU-TRAC suspension system features independent trailing arms for each front wheel with NEOCON struts, containing energy absorbing gas and compressible NEOCON-E™ fluid, mounted between the king pins and the frame. This arrangement allows a wider front track that provides a better ride, improved stability and a reduced turning circle. The rear axle housing has an A-frame mounting. The rear NEOCON struts are mounted in a more vertical position which allows a more pure axial loading and reduces the tractive and braking forces transmitted to the nose cone.

NEOCON struts outperform competitive strut designs by improving isolation, stability, and control. Improved isolation means reduced impact loading on the structural members of the machine and greater operator comfort, resulting in longer equipment life and increased productivity. Improved stability means more consistent dynamic response of the machine to fluctuating load energy, resulting in predictable machine performance. The improved control means better machine maneuverability.

The Hitachi frame and ACCU-TRAC suspension system are designed to work in unison to provide maximum structural integrity and operator comfort. The fabricated rectangular frame rail construction provides superior resistance to bending and torsional loads while eliminating unnecessary weight. The unique ACCU-TRAC independent trailing arm suspension absorbs haul road input, minimizing suspension-induced frame twisting while providing independent tire action. NEOCON ride struts are mounted with spherical bushings, eliminating extreme sidewall forces by ensuring a purely axial input to the ride strut. The wide track stance of the ACCU-TRAC suspension system and the long wheel base assure a more stable, comfortable ride.

The horizontal stiffener design of the Hitachi body minimizes stress concentrations in any one area. Load shocks are dissipated over the entire body length.

The closely spaced floor stiffeners provide additional protection by minimizing distance between unsupported areas.



## SERVICE CAPACITIES

	L
Crankcase (includes filters)	83.3
Transmission, Cooler and Lines	93.3
Cooling System	224.5
Fuel Tank	700
Hydraulics	
Hoist Tank and System	256
Steering Tank and System	112
Drive Axle (2 wheels and differential)	103
Windshield Washer Fluid	5.7

## STANDARD EQUIPMENT

### GENERAL

ACCU-TRAC suspension system	Ground level auxiliary start receptacle
All-hydraulic braking	Guard rails
Allison H6610A automatic transmission	Hoist interlock
Battery disconnect switch	Hoist tank sight guage
Body down cushioning	ISO decals
Body down indicator	Load/dump brake
Body up speed restriction	Mirrors, left and right, hand adjustable
Canopy spill guard	Mud flaps
Continuous body heating	NEOCON-E suspension struts
Cooling system sight guage	Park brake - dry disc
Cooling system surge tank	Park brake interlock
Driveline guard, front	Radiator grille guard
Electric horns	Reverse alarm and light
Electric start	Rock ejector bars
Electronic hoist	Steering accumulator
Engine belt protection	Steering tank sight guage
Fan guard	Tires 24.00 R35
Fenders	Tow points, front
Fixed steering stops	Transmission guard
Front brake cut-off switch	Transmission sight guage
Fuel tank level guage	Two speed reverse

## BODY

The body has been made to the flat floor, flat tail chute design.

The rear hinge has been designed to cause the hinge pin to float when the body is in the fully lowered position.

The weight of the body and payload is distributed across rubber body pads that are evenly spread across the length of the body rail-box that rests on the truck frame.

Thickness:

	mm	(in)
Floor	18	(0.69)
Front	10	(0.38)
Sides	8	(0.31)
Canopy	6	(0.25)
Optional Body Liners (Medium Duty)		
Floor & Corners	10	(0.38)
Sides & Front	6	(0.25)
End Protection	10	(0.38)
Optional Body Liners (Heavy Duty)		
Floor & Corners	13	(0.50)
Sides & Front	8	(0.31)
End Protection	10	(0.38)
Optional Partial Liner (Heavy Duty)		
Floor & Corners	13	(0.50)
End Protection	10	(0.38)
Optional Rock Cap		
Top of the Body Side Plate	10	(0.38)

## CAB

Air filtration/replaceable element	Quick connect test ports
Ash tray	Roll down operator window
Cab interior light	Rubber floor mat
Cigar lighter, 24 volt	Safety glass
Door locks	Seat belts, retractable
Foot rest, left	Seat, mechanical, adjustable, multi-position
Heater and defroster	Sunvisor
Integral ROPS/FOPS cab	Tilt/telescoping steering wheel
Integrated engine diagnostics connector	Tinted glass, all windows
Integrated transmission diagnostics connector	12 volt accessory connection
ISO driver envelope	Windshield washer
Modular instrumentation	Windshield wiper, intermittent

## INDICATOR LIGHTS

Battery charge	Filter restrictions
Body up	High beam
Brake system oil pressure	Parking brake applied
Central warning (caution)	Steering oil pressure
Central warning (stop)	Steering oil temperature
Engine coolant level	Transmission malfunction
Engine oil pressure	Transmission oil pressure
Engine, other malfunctions	Turn signal / hazard

## GAUGES

Brake oil temperature	Odometer
Converter oil temperature	Speedometer
Engine coolant temperature	Steering / brake oil pressure
Fuel guage	Tachometer
Hourmeter, engine	

## MACHINE LIGHTS

Back-up light	Stop & tail (2)
Clearance light - front (2)	Amber turn signals and four-way flashers
Clearance light - rear (2)	
Halogen head lights (4)	

Standard and optional equipment may vary from country to country. Special options provided on request. All specifications are subject to change without notice.

Note: Dimensions shown are for empty machine with 24.00R35(\*\*)E4 tires.

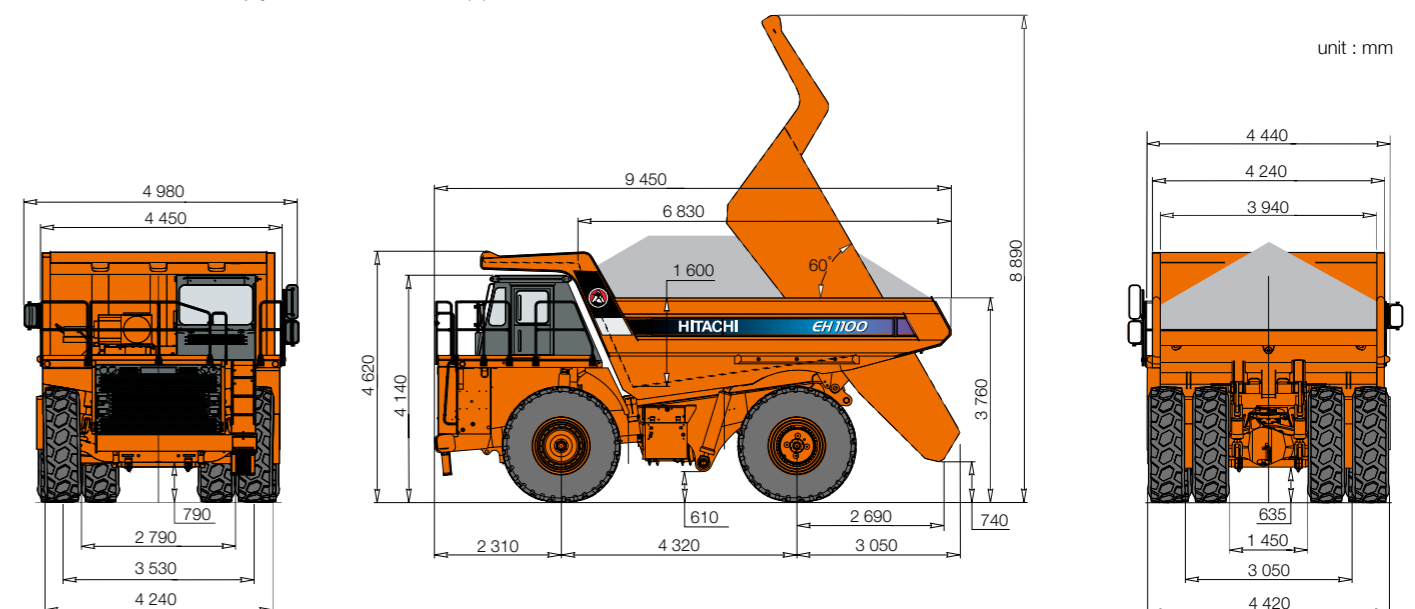

## OPTIONAL EQUIPMENT

### CAB

Active Traction Control (ATC) w/ Electronic Downhill Speed Control (EDSC)	Circuit Breakers in place of fuses DC - DC, 24 to 12 V convertor
Air conditioning	Electric RS and LS power windows
Air suspension seat w/ lumbar	HAULTRONICS III load monitoring system
Air suspension seat, semi-active, w/ heat, w/ lumbar, 3 point seat belts	Hill hold brake
AM-FM radio w/ CD	Speakers, antenna and wiring only
	Trainers seat

### CHASSIS

5 piece rims	Fluid drain kit - FEMCO
Additional backup lights - halogen, mudguard mounted	Fluid sampling points
Additional backup lights - HID, mudguard mounted	Fog lights
Ansul fire suppression, manually actuated	Front underview mirror
Body liners (400BHN) plates, medium heavy duty or partial	Ground level engine shutdown
Canopy spill guard extension	Hi-lite green paint
Cold weather package	Lube system, centralized
Mild cold weather package (0 deg C to -20 deg C) (32 deg F to -4 deg F)	Lube system, Groeneveld
Extreme cold weather package (-20 deg C to -35 deg C) (-4 deg F to -31 deg F)	Lube system, Lincoln
Electrically heated mirrors	Premium light package (HID headlights, LED marker lights)
Engine access step	Rear view camera
Engine compartment lights	Rock cap
Extra reverse light on light mount bracket	Service center
Fire extinguisher, deck mounted	Side extensions
	Side Mudguards, mounted to cab deck
	Spare rim
	Spare tire with rim
	Tires (type & rating)
	Transynd transmission fluid
	Unit sound suppression

### MISCELLANEOUS

Extra operators manual	Service Manuals - hardcopy
Extra parts manual - hardcopy	

# Performance Data

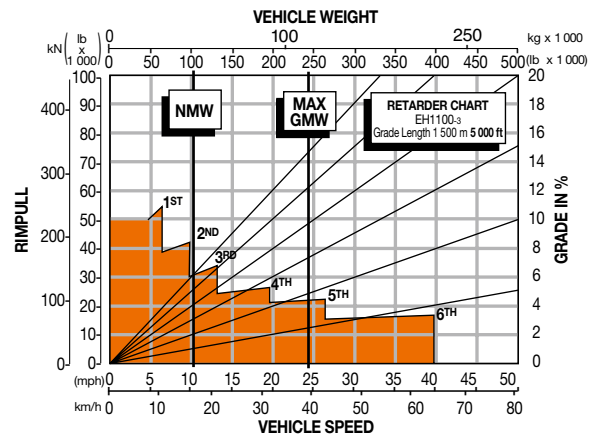
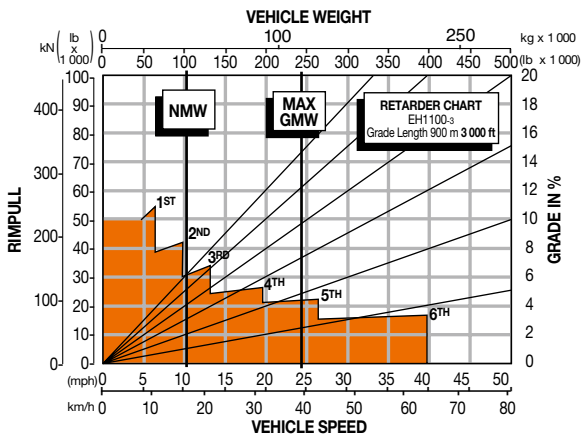
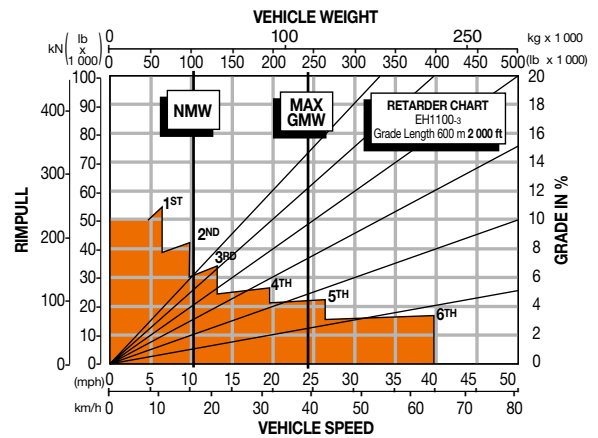
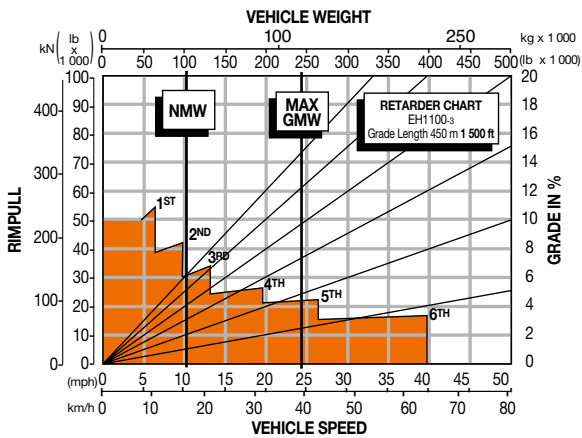
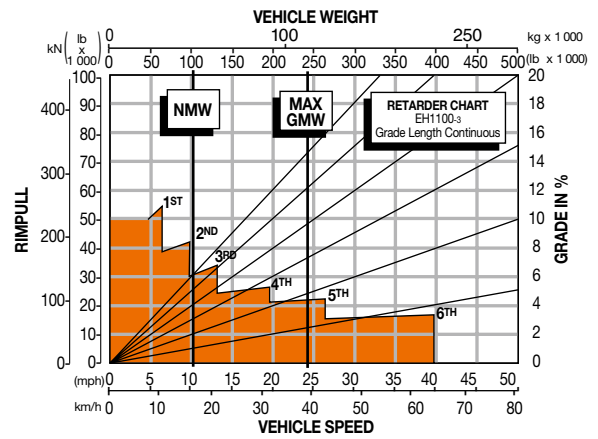
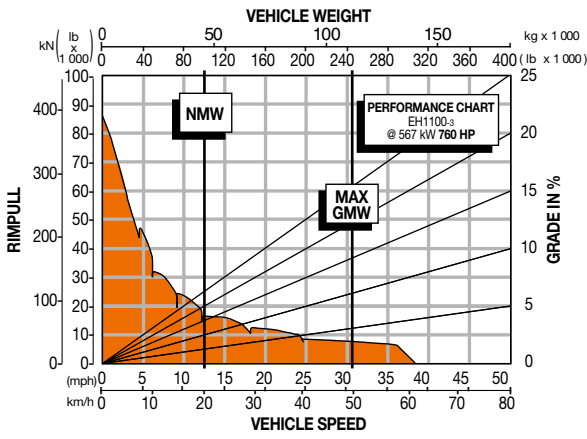

## NOTES:

Diagonal lines represent total resistance (Grade % plus rolling resistance %).

Charts based on 0 % rolling resistance, standard power of engine, standard tires and gearing unless otherwise stated.

1. Find the total resistance on diagonal lines on right-hand border of rimpull or retarder chart.
2. Follow the diagonal line downward and intersect the NMW or GMW weight line.
3. From intersection, read horizontally right or left to intersect the rimpull or retarder curve.
4. Read down for machine speed.

These specifications are subject to change without notice.

Illustrations and photos show the standard models, and may or may not include optional equipment, accessories, and all standard equipment with some differences in color and features.

Before use, read and understand the Operator's Manual for proper operation.